

Direct Sampling SDR receiver

ColibriNANO

Opens new radio horizons

USER MANUAL

1. READ IT FIRST	5
1.1 Congratulations	5
1.2 Features	5
1.3 Precautions	5
1.4 ExpertSDR2 Software License Agreement	6
1.5 Copyrights	7
1.6 Contacts	7
2. HARDWARE DESCRIPTION	8
2.1 Antenna	9
2.2 Grounding	9
3. ExpertSDR2 SOFTWARE DESCRIPTION	10
3.1 Global controls panel	10
3.2 Software receiver settings	12
3.2.1 Receiver control panel	12
3.2.2 Frequency and S-meter indicators	15
3.2.3 DSP control panel	17
3.2.4 Panorama description	20
3.2.4.1 Spectrum Scope	20
3.2.4.1.1 Spectrum Scope scaling	20
3.2.4.2 Waterfall	22
3.2.5 Status bar	22
3.3 Options	23
3.3.1 Device menu	23
3.3.1.1 VAC	23
3.3.1.2 DSP	24
3.3.1.3 Expert	28
3.3.2 Sound card menu	29
3.3.2.1 Sound card	29
3.3.2.2 Line output	29
3.3.3 Display menu	30
3.3.3.1 Main window	31
3.3.3.2 Spectrum	32
3.3.3.3 Waterfall	34
3.3.3.4 Grid	35
3.3.3.5 Filter	35
3.3.3.6 Background	36
3.3.4 CAT menu	38
3.3.4.1 ECATv1	38
3.3.4.2 OmniRig	39
3.3.5 Panel menu	40
3.3.6 Features menu	43
3.3.7 ExpertSync menu	44
3.3.8 CW Skimmer menu	45
3.3.9 Shortcuts menu	47

3.3.10	IQ Recorder menu	48
3.3.11	TCI menu	49
3.3.12	Spot settings menu	49
4.	TECHNICAL CHARACTERISTICS	51
4.1	Receiver	51
4.2	Other	52
5.	RECEIVER OPERATIONS	53
5.1	First set up	53
5.2	Remote operation	54
5.3	Frequency Tuning	54
5.4	RIT	55
5.5	Digital modes operation	56

1 READ IT FIRST

1.1 Congratulations

On behalf of the whole Expert Electronics company, we'd like to thank you for purchasing the ColibriNANO SDR receiver!

The ColibriNANO receiver is the best receiver in the USB-stick form factor category. It has the best price/value ratio, which is perfect if you want to set up a remote receiver in a rural area, with clean air!

1.2 Features

The ColibriNANO opens new horizons for HF band enthusiasts, thanks to its 14-bit ADC, which provides a ~110 dB BDR and up to 3 MHz sample rate. A 0.5 ppm local oscillator gives the ColibriNANO a great frequency stability. Using the ColibriNANO remotely, in some rural area will give you the lowest air noise while won't rob you from any comfort or functionality. The ColibriNANO can be controlled by the ExpertSDR2 software and compatible with other popular HAM software such as HSDR, SDRSharp via the ExtIO library.

Main features and capabilities of the receiver

- RX path based on **DDC** (Direct Down-Conversion) architecture
- Frequency coverage (in undersampling mode) up to 500 MHz
- Software receiver bandwidth up to 3 MHz + SubRX
- Automatic ATT/preamp with a 0.5 dB step in a range from -31.5 up to +6
- **ExpertRemote system** provides full remote control of the receiver
- Synchronization with transceivers via **CAT interface**
- IQ output via Virtual Audio Cable (**VAC**)
- Compatibility with **any sound card** installed on your PC for the audio output
- Special interface to control the **CW Skimmer**
- **TCI interface** for seamless connection with third-party software like **SDC** (with its own Skimmer), **LogHX**, **SWISSLOG** and **RUMlog**, more are coming

1.3 Precautions

To prevent any damage to the receiver, please read these operating rules carefully before attempting to operate on the air.

- Visually inspect the receiver for the absence of mechanical damages before connecting it to PC

- If the receiver has been stored in abnormal climatic conditions, it is recommended to keep it in normal operating temperatures for at least 2 hours before connecting to a PC
- It is forbidden to use the receiver in dusted rooms and expose it to direct sunlight for a long time
- **DO NOT** use the receiver in temperatures lower than -10°C (14°F) and higher than +60°C (140°F)
- Avoid the exposure of the atmospheric downfalls on the receiver and never spill any liquids (especially aggressive) on it
- **It is forbidden to use the receiver during storms!**
- **Always disconnect the antenna** from the receiver when not in use, or if there is a danger of atmospheric electricity
- **Don't open the receiver**, it has radio elements, which have high-sensitivity to the static electricity. This document contains all necessary information about the internal design to satisfy the Users' curiosity. To repair the receiver, ask the manufacturer
- Ensure the receiver and antenna cable is free from the effects of electromagnetic interference and uncontrolled currents and voltages
- To avoid damage to the receiver it should only be operated by licensed HAMs
- Keep the receiver out of the reach of children
- If the receiver emits an abnormal odor, or smoke, **immediately** turn it OFF and disconnect from PC. Contact your closest Expert Electronics dealer for advice
- Ground the antenna-mast and antenna-feeders to avoid accumulation of atmospheric static electricity on them
- **Always** use ferrite beads on antenna cable, connected to the receiver

1.4 ExpertSDR2 Software License Agreement

ExpertSDR2 software is the proprietary product and intellectual property of Expert Electronics. It is forbidden to modify, copy or disclose to third parties ExpertSDR2 software distribution.

Official versions of the software are published on the manufacturers website in section "ColibriNANO receiver / Downloads".

New versions of the ColibriNANO receiver software may have different titles from time to time. This license agreement applies to all new versions of the software and may be supplemented and / or amended unilaterally by Expert Electronics.

The manufacturer reserves the right to alter and / or improve the ColibriNANO receiver software, adding new features and bug fixes. In this regard, the software may be different from the description herein. Ask your closest dealer on the availability of new, more complete version of the User Manual, or look for them on the official website of the manufacturer in the section "ColibriNANO receiver / Documentation".

Users of the ColibriNANO receiver can update the software by themselves, by downloading from the official website of the Expert Electronics company.

The manufacturer is not responsible for the consequences of the user utilizing an unofficial or modified version of ExpertSDR2 software and/or changes the settings or other files which are related to the ExpertSDR2 functionality.

The manufacturer assumes no responsibility for the material, moral or any other kind of damage, whether expressed or implied, caused by using of a third-party software.

The manufacturer assumes no responsibility for the material, moral or any other kind of damage, whether expressed or implied, caused by using of external devices along with the ColibriNANO receiver.

1.5 Copyrights

Expert Electronics company holds copyrights for the ColibriNANO receiver, intellectual property: ExpertSDR2 software and all User Manuals and Instructions for the device and software.

It is forbidden to present this document as your own, sell it or use it in any other commercial activity.

Expert Electronics company does not guarantee, that the functions and their qualities described in this manual, and also combinations which were not described in the manual, comply with the User purposes, if it is not mentioned in the Manual. Expert Electronics company does bear any responsibility for the material, moral or other kinds of damage expressed or implied by such actions.

1.6 Contacts

MANUFACTURER

Expert Electronics

Web-site: www.eesdr.com

E-mail: info@sunsdr.com

You can contact us via mentioned above mail address about: your orders, inquiries, technical support, software support.

2 HARDWARE DESCRIPTION

Block Diagram



Architecture description

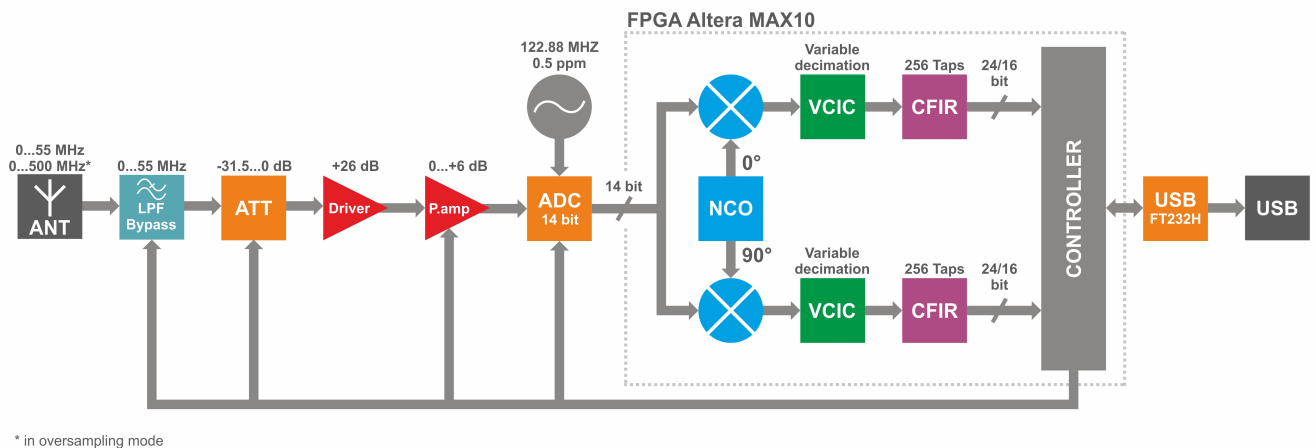

Receive path consists of the following functional units:

- **ANT** - antenna connector.
- **LPF** - Low Pass Filter with 55 MHz bandwidth. This filter allows you to receive signals in the first Nyquist zone and eliminates signals from the second Nyquist zone. It switches ON/OFF automatically according to the panorama center, **ON** - inside the 0-55 MHz range and **OFF** - above 55 MHz.
- **ATT** - attenuator -31.5...0 dB with 0.5 dB step, it allows to “weaken” signals to eliminate the receiver overload while receiving strong signals.
- **Driver** - it’s purpose is to amplify the signal and transfer it to the ADC.
- **Preamp** - preamplifier 0...+6 dB, it can additionally amplify signals.
- **TCXO** - Temperature-Compensated Crystal Oscillator with 122.88 MHz frequency. This is a high-stability oscillator with temperature instability 0.5 ppm.
- **ADC** - high-speed Analog-to-Digital Converter with 14-bit resolution and 122.88 MHz sample rate. ADC is the heart of the receiver; it is responsible for direct sampling of all signals in the 55 MHz bandwidth.
- **FPGA** - Field Programmable Gate Array. It makes all high-speed processing operations. Inside the FPGA happens the first down conversion of signals. It is similar to the first converter

in a classic super-heterodyne, but all operations are processed in a mathematic order with binary logic.

- **Controller** - It controls all ColibriNANO systems and performs the data exchange between the receiver and the USB controller.
- **USB FT232H** - It performs the data exchange between the Controller and a PC.

2.1 Antenna

Before connecting the antenna, check the integrity of the antenna-feeder path.

For best results, the antenna should have an impedance of 50 Ohm to match the 50 Ohm impedance of the receiver.

The antenna should have an SWR level not worse than 1.5:1. If the SWR is worse than 1.5:1, match the cable and the antenna to the desired level.

Warning!

- ① **Always use E-type ferrite beads on antenna and other cables, connected to the receiver!**
-

2.2 Grounding

To eliminate the risk of electric shock it is essential to use a reliable grounding in the setup with the ColibriNANO receiver.

Warning!

- ① **Never use water or gas pipes for grounding!**
-

3 ExpertSDR2 SOFTWARE DESCRIPTION

Software settings which won't be mentioned or addressed in this manual, are set by default or provided to the user's self-study and experiments. All the unmentioned settings cannot cause the fatal damage of the ColibriNANO receiver hardware, so you can safely experiment with them. You're dealing with the software-defined radio - SDR, the main settings and signal processing is held in the software.

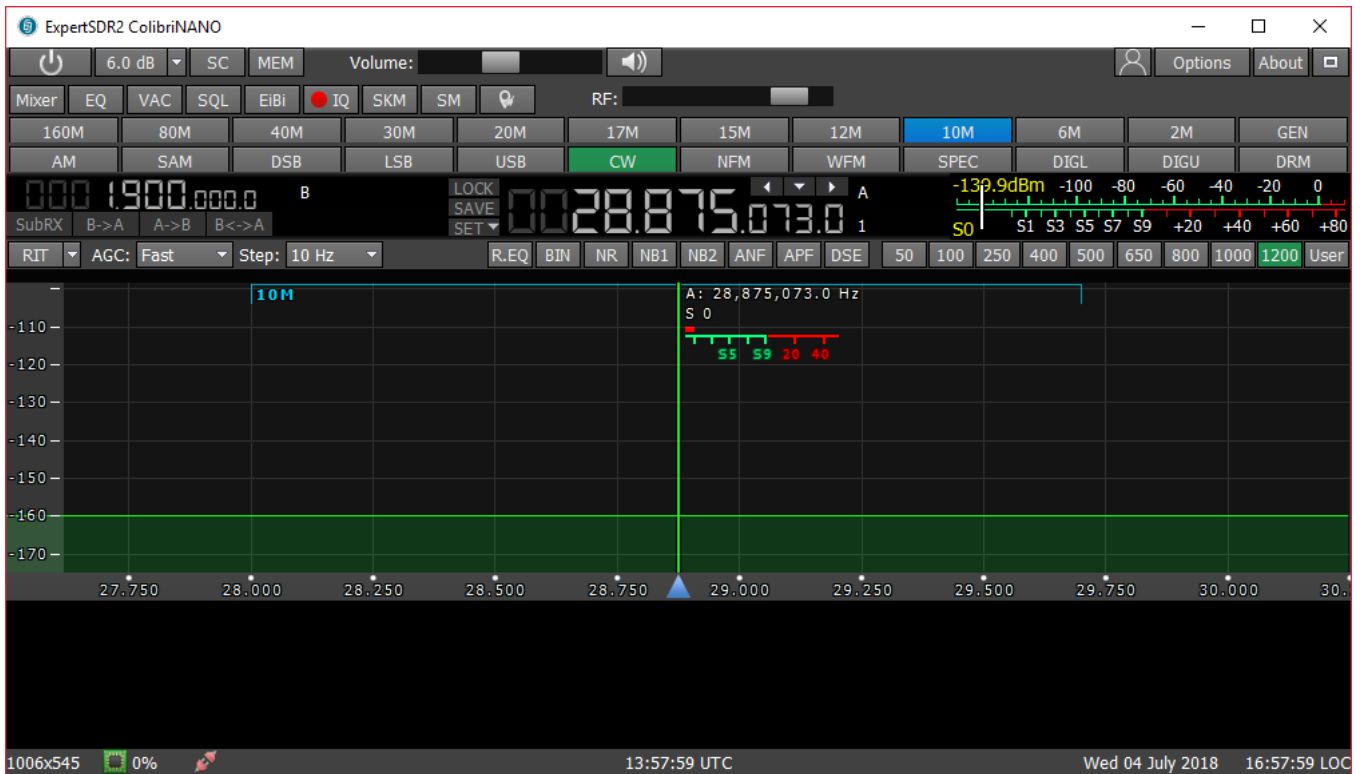

3.1 Global controls panel



This panel consists of the following buttons:

 - the **Start** button switches on/off the ExpertSDR2 software.

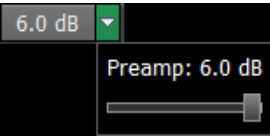
 - **Attenuator** level can be set in the drop down menu with a slider (0.5 dB step) or by successive presses of the indicator button, which cycles upwards the attenuation coefficient with 5 db step, from -30dB up to +5 dB.

Note:

- **Attenuator specifics** : S-meter values and audio level have program compensation when you use the attenuator because signal level on the antenna input is always the same and

doesn't depend on the attenuator level. With this solution, a user doesn't need to calculate real values on his own, every time when the -20-dB attenuator is used. Also, he doesn't need to adjust AF or RF level every time when the -20-dB attenuator is used, like in most classic receivers.

- Attenuator influences only receiving dynamic range, S-meter and audio level stay the same. If you disconnect antenna you can see how receiver's noises are changing when you switch the ATT. Receiver's noise level is lower when you select ATT 0 dB, it means that RX sensitivity is higher. When you select ATT -20 dB, it means that RX noise level is higher, but RX sensitivity is worse. It is done in the hardware.

SC - enable/disable sound output from the PC's sound card (**SC**).

MEM - enable/disable button of the frequency memory panel (**MEM**).

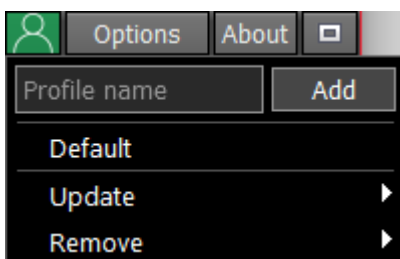
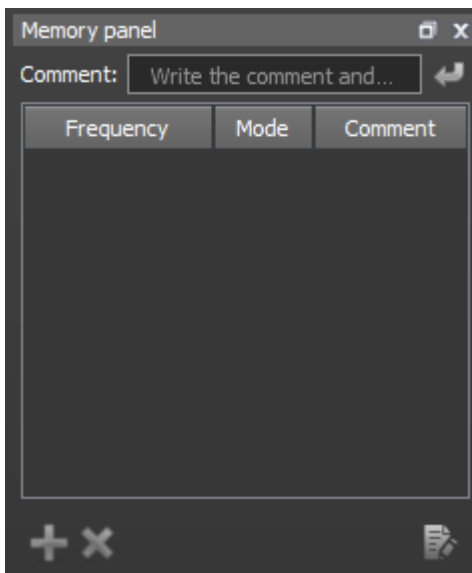

- In the **Profile** manager menu you can:

- add a new profile, by entering the name of the profile in the "Profile name" field and pressing **Add** button.
- set the settings of the whole program to the default state, by the **Default** button.
- **Update** the settings of the certain profile from the list to the current settings.
- **Remove** the certain profile from the list.

Note:

- All new profiles will be stacked up to the drop-down menu as a new line.

Options - **Options** menu described [options](#)¹²³.

About - **About** button opens the new window with the info about current version of the ExpertSDR2 software:



Fullscreen - pressing the **Fullscreen** mode button will unfold the software window on the whole screen.

Volume: - **Volume** slider. Volume slider. This setting is global, it is not stored per band, it affects the LF output volume on the PC's sound card. Speaker icon has the mute function.

3.2 Software receiver settings

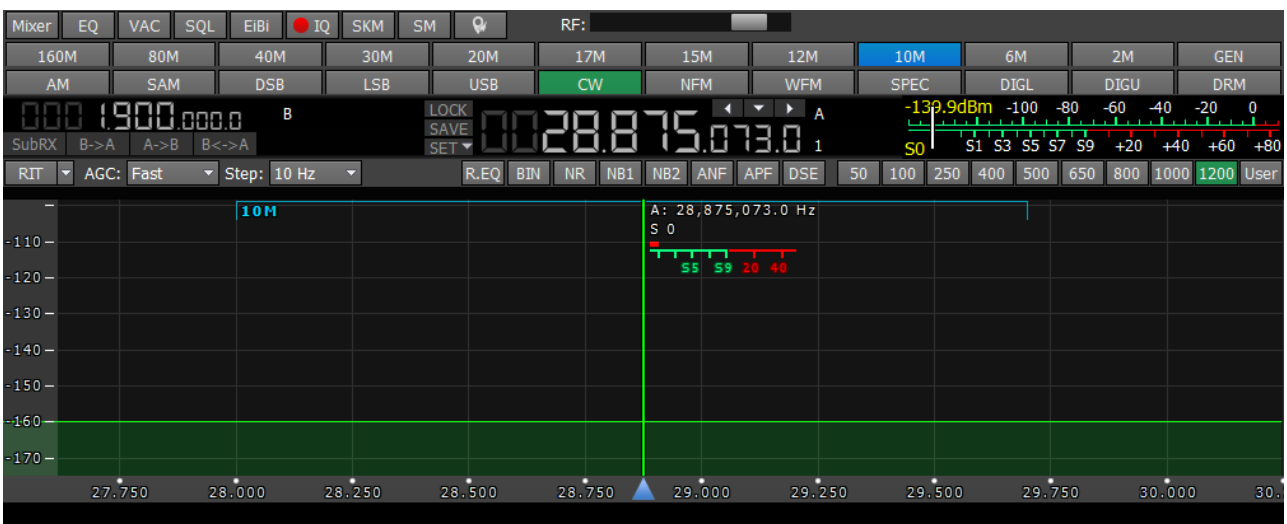

These settings are divided into four logical parts, described below.

3.2.1 Receiver control panel

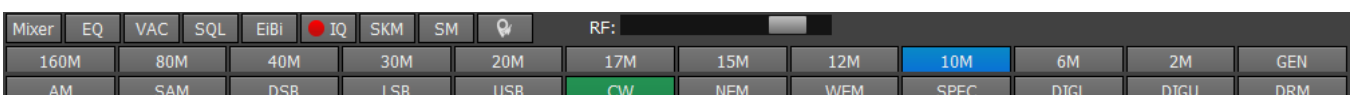

Mixer - separate volume and balance controls for VFO A and VFO B (**Mixer**).

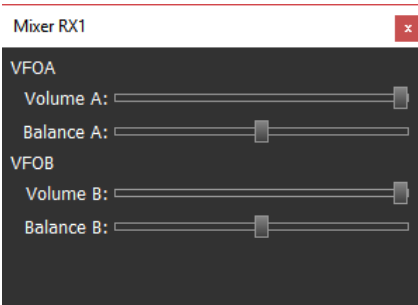

EQ - open the 18-band RX equalizer menu (**EQ**).

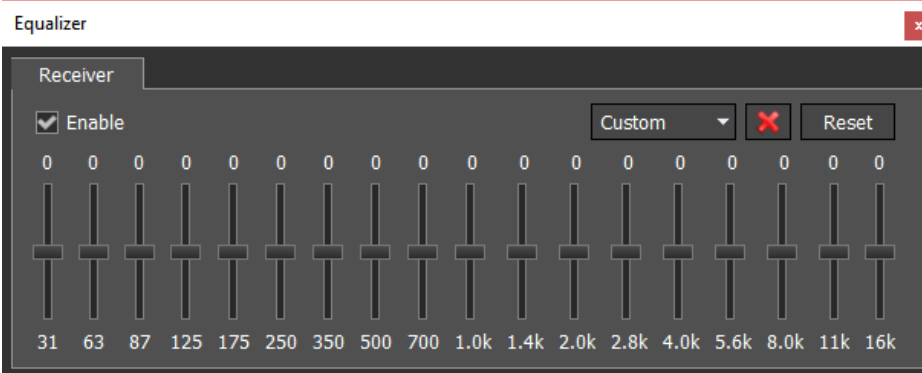

VAC - button enables the **VAC** (data exchange via Virtual Audio Cables).

SQL - button enables the squelch (**SQL**). Displayed as the vertical yellow needle on the S-meter. If the air signal - green needle, surpasses the SQL trigger threshold - yellow needle, then you'll hear the sound of the receiving station on the receiver's LF output. If the signal level is lower than the trigger threshold, you'll hear nothing.

Mute - button mutes LF signal (**Mute**).

EiBi - show the HF stations markers on the panorama from the EiBi database (**EiBi**). Hover with the mouse pointer on the station frequency and you'll see its name.



 - IQ-files recording is required for storing the RX bandwidth panorama (**IQ**). The file is saved to the C:\Users\User_Name\ExpertSDR2\wave\.

 - turn on the CW Skimmer, more details in [CW Skimmer](#)⁴⁵ (**SKM**).

 - bigger S-meter button (**SM**).



- the S-meter window can be separated from the software window and moved to any place on the screen.

S-meter - Displays the level of the received signals in the receiver filter bandwidth (in units).

 - press this button to clear the panorama of all displayed spots.

When you enable the **NFM** mode, one additional button appear:

 - **Continuous Tone-Coded Squelch System** button. In some cases, it's required to activate the squelch with the help of the **CTCSS** tones.

You set the **CTCSS** level relatively to your voice signal.

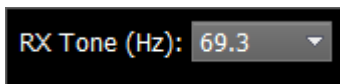

1. Set the NFM mode.
2. Set the receiver's tone frequency in the RX Tone input-box.
3. Press the CTCSS button to activate the CTCSS mode.
4. Receive signals with CTCSS tone.

When you enable the **WFM** mode, one additional button appears:

 - when enabled, this function allows the software to automatically detect whether the station is strong or not and lets you listen to it in **stereo** mode.

 - **AGC** sensitivity control slider (Automatic Gain Control on classic transceiver). The adjusted level is saved per band.

A panel of mode buttons:



- AM** - Amplitude Modulation
- SAM** - Synchronous Amplitude Modulation
- DSB** - Double Side Band
- LSB** - Lower Side Band
- USB** - Upper Side Band
- CW** - CW mode. It works in CW-U for all bands. It cannot be changed.
- NFM** - Narrow FM
- WFM** - Wide FM, supports receiving of the stereo signals
- SPEC** - Spectrum mode. Receive the pure signal without any demodulation (panadapter bandwidth). The idea is to receive pure signal then pass it out via VAC or PC's sound-card
- DIGL** - Digital Lower Side Band. Connect a third-party software (is not supplied) to the receiver software for operating in digital modes
- DIGU** - Digital Upper Side Band. Connect a third-party software (is not supplied) to the receiver software for operating in digital modes
- DRM** - Digital Radio Mondiale, 10 kHz filter with 5 kHz IF to work with the external decoder of the DRM signals. Connect third-party software (is not supplied) to the receiver software for decoding of the DRM signals



160M - 2M - amateur bands

GEN - if out of the amateur bands

3.2.2 Frequency and S-meter indicators

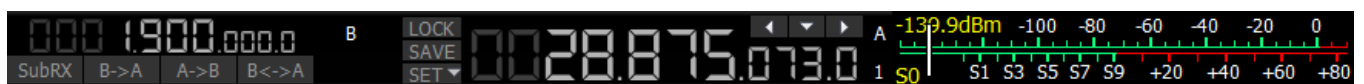

Mainly, this panel consists of the visual indicators, like the VFO A/B frequencies, the signal level on the antenna's input (S-meter) and several control buttons.

Displaying elements:



Note:

- You won't hear the audio from the VFO B if it is out of the panorama bandwidth.

Sub-receiver control unit:

SubRX **B->A** **A->B** **B<->A** - **SubRX** - enable sub-receiver. If you want to listen to the VFO A and VFO B frequencies simultaneously, use the Sub-receiver.

1. Activate the Sub-receiver by pressing the **SubRX** button.
2. Set the required VFO B frequency.
3. Listen to the VFO A and VFO B frequencies simultaneously.

Note:

- You can switch the point and click control on the panorama between VFO A and VFO B receivers, by pressing the middle mouse button. You'll control the RX with the same color to the mouse cursor.
- When you change the band the **SubRX** is disabled.

B>A - assign the VFO B frequency to VFO A

A>B - assign the VFO A frequency to VFO B

B<>A - swap frequencies between the VFO A and VFO B



- VFO A frequency indicator (main receiver).

Main receiver control unit:



LOCK - lock the VFO A frequency tuning.

SAVE - save the current VFO A frequency and mode type in the memory panel.

SET - manual frequency input for VFO A or VFO B.

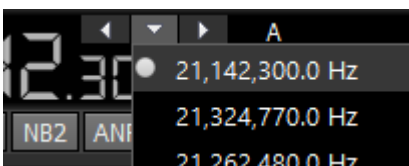

- **Navigation buttons**. The quick memory cells are automatically stored with the frequencies if the receiver stands still over a second. Then those frequencies can be selected in order back and forth, as in an internet browser. The total stack contains 16 cells.



1 - **Band Stacking Memories** indicator (VFO A only). Each memory slot has a frequency, mode, and filter settings. Each band has three memory slots associated with it. Successive presses of a band button will cycle through the stored memory slots. It might be useful for quick frequency and mode changes within a band. To replace one memory slot:

1. click the required band button you would like to modify.
2. change the frequency (within a selected band), mode, and filter to the required settings.
3. click the band button again to save the values.

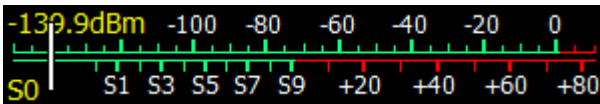

S-meter - by default this scale displays the power level of the signals in the RX filter bandwidth. The scale has two grade types: in S-units and in dBm. The signal strength displayed in dBm to mW (yellow figure) in the top left corner of the S-Meter.

Note:

- *S-Meter in the ExpertSDR2 has two different calibrations for HF (0-30 MHz) and VHF (30-300 MHz). HF and VHF signals with the same dBm level have different S-scale values. For example: HF S9 = -73 dBm = 50 uV (50 Ohm), VHF S9 = -93 dBm = 5 uV (50 Ohm). S-Meter in the ExpertSDR2 corresponds to the IARU recommendations, each device is calibrated at the manufacturing.*

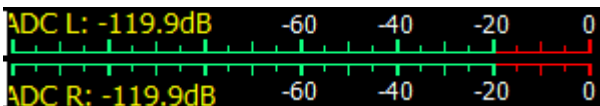

- ADC type displays the power in each quadrature channel (double scale).

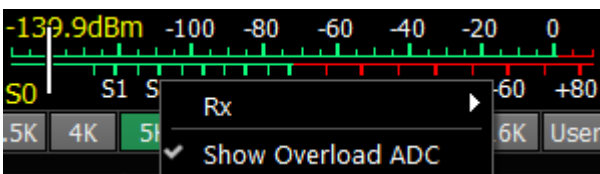

- **Show Overload ADC** indicator, enable it to track the ADC status, as soon as ADC overloads, the S-meter will flash with **red** light.

3.2.3 DSP control panel



RIT - Receive Incremental Tuning.

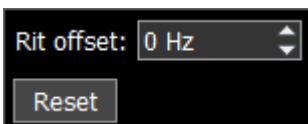

- In the drop-down menu, you can set the frequency offset in Hz. **Reset** - resets the offset value to zero (more details in [RIT](#)⁵⁵).

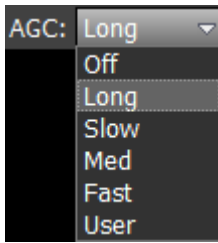

- **AGC** presets menu. In the drop-down menu, you can select the receiver's AGC preset:

OFF - AGC is off.

LONG - preset with long AGC reaction (approximately 750 ms). Recommended for phone modes.

SLOW - preset with slow AGC reaction (approximately 500 ms). Recommended for phone, digital modes.

MED - preset with medium AGC reaction (approximately 250 ms). Recommended for CW, digital modes.

FAST - preset with fast AGC reaction (approximately 100 ms). Recommended for CW, digital modes.

USER - preset with custom AGC reaction (by default the slowest 1000 ms).

Note:

- *AGC settings influence the quality of the received signal. Be careful selecting the AGC preset or tuning your own preset.*
-

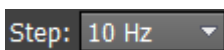

- **Step** list allows to change the step of the **mouse wheel** in the range from 0.1 Hz to 100 kHz.

DSP functions:



- enable the RX equalizer (enabled on the picture).



- binaural audio mode (the phasing of the audio signal within the RX filter gives a stereo-like effect).



- enable the adaptive Noise Reduction to clean the signal from noise interferences.



- enable the First Noise Blanker for impulse interference.



- enable the Second Noise Blanker for impulse interference.

Note:

- *The NB1 and NB2 algorithms are different. Try each of them to reach the best impulse interference reduction. NB1 and NB2 Noise Blankers can be used simultaneously.*
-

ANF - enable Automatic Notch Filter for adaptive rejection of the narrowband interference in the receiving band (interference, carrier signals, CW signals, etc.).

Note:

- If there are no interference, ANF could slightly affect the reception quality of the desired signal. Disable ANF, if you don't need it.
-

APF - enable Analog Pick Filter, it creates the triangle filter's AFC (amplitude-frequency characteristic) in the filter bandpass.

DSE - enable Digital Surround Effect for CW signals, it provides a space orientation in stereo phones.

Note:

- This algorithm provides panorama acoustic of the CW signals in the filter bandwidth, depending on their position in the filter:
 - if the received CW signal is in the receive filter bandwidth and lower the tuned frequency, it will be louder in the left phone;
 - if the received CW signal is in the receive filter bandwidth and higher the tuned frequency, it will be louder in the right phone;
 - if the received CW signal is in the receive filter bandwidth and in the middle of the tuned frequency, it will be equally loud in both ears.
-

RX filter bandwidth presets. Presets list depends on the mode type:

3K 3.5K 4K 5K 6K 8K 10K 12K 16K User - AM, SAM, DSB, NFM modes (3 - 16 kHz);

1.8K 2K 2.2K 2.5K 2.7K 2.9K 3.0K 3.3K 3.5K User - LSB, USB, DIGL, DIGU modes (1.8 - 3.5 kHz);

50 100 250 400 500 650 800 1000 1200 User - CW mode (50 - 1200 Hz);

50K 80K 110K 120K 150K 180K 240K 280K 310K User - WFM mode (50 - 310 kHz);

10K - DRM mode (has one fixed bandwidth 10 kHz);

User - user can adjust the RX filter bandwidth by himself (available at any modulation type except DRM).

3.2.4 Panorama description

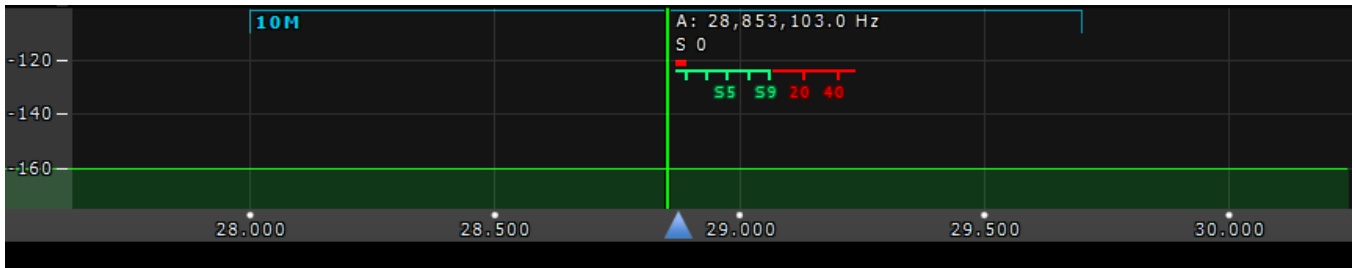

The panorama consists of two parts separated by the horizontal scale: 1) Spectrum Scope and 2) Waterfall.

3.2.4.1 Spectrum Scope

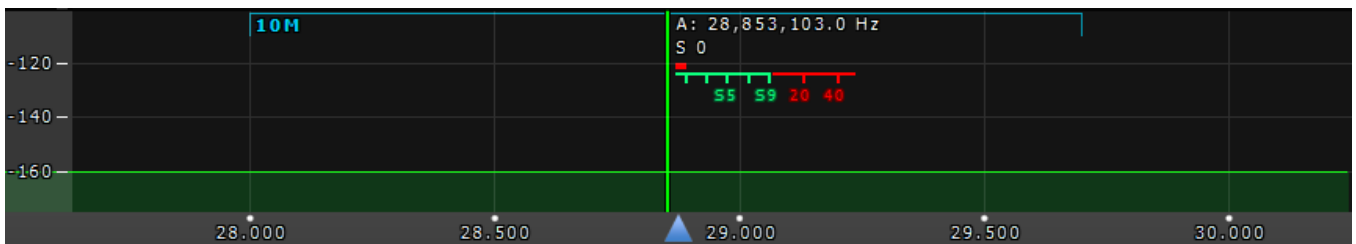

In this window you can see the spectrum, with the sample rate from 48 kHz up to 3 MHz (adjustable by User) and the RX filter to tune and listen to the stations.

There is a vertical scale to the left of the spectrum scope, it indicates the power level of signals in dBm. Amateur band indicator displayed as the blue line on top of the graph with the name of the band, it shows the limits of the amateur band.

RX filter position is indicated by the vertical green line. To the right of the line indicated its precise tuning frequency (can be switched off in Options). Below the frequency you can see the signal level on the S-Meter scale (can be switched off in Options). RX filter bandwidth displayed as the translucent gray area around the tuning frequency. You can listen to everything within this band.

Spectrum is displayed as a line on the spectrum scope, but it also may have a filling color. You can change spectrum rendering mode, line color, filling color, transparency, etc. in the software Options (more details in the [Spectrum tab](#)³²).

3.2.4.1.1 Spectrum Scope scaling

If you move the mouse cursor over the vertical scale a hand will appear. Press and hold the right mouse button, then move it up/down to change the dBm scaling or press and hold the left mouse button, then move it up/down to change the spectrum level.

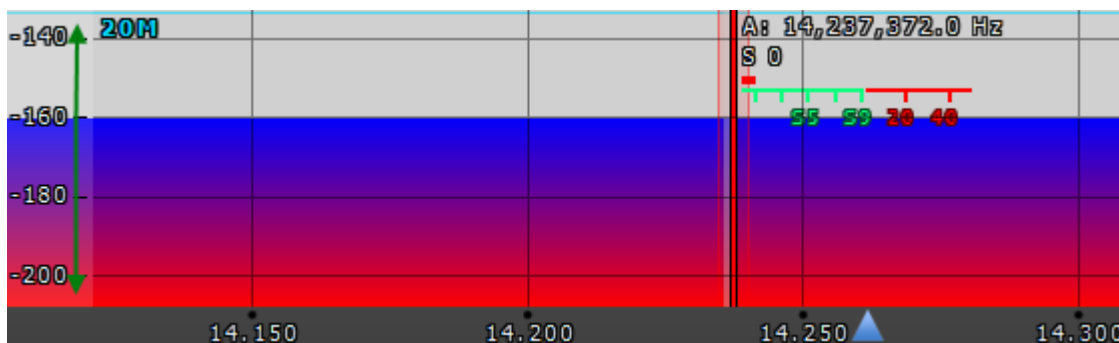

The horizontal scale between the spectrum scope and waterfall shows the frequency of the certain point on the spectrum. If you move the mouse cursor over the horizontal scale a hand will appear. Press and hold the right mouse button, then move it left/right to zoom in/out the panorama or press and hold the left mouse button, then move it up/down to change the ratio of the spectrum to waterfall.

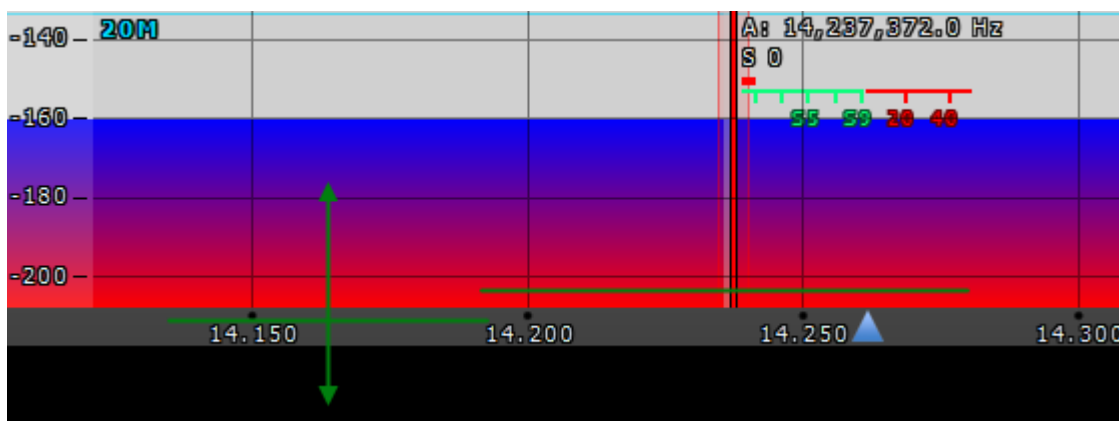

Zoom in/out of the panorama is carried out relative to the **Zoom position** marker.

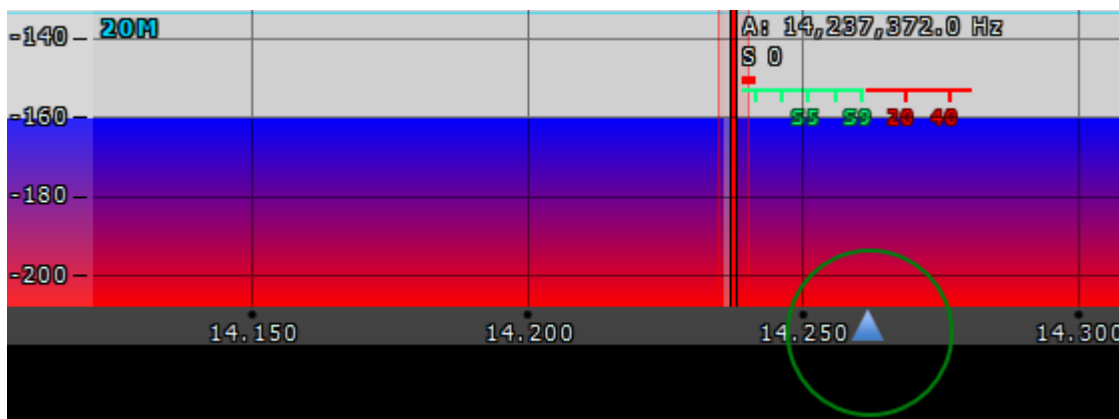

There are two ways to change the **Zoom position**:

1. Press and hold the left mouse button on the **Zoom marker** and drag it left/right,
2. Click the mouse wheel on the frequency scale.

3.2.4.2 Waterfall

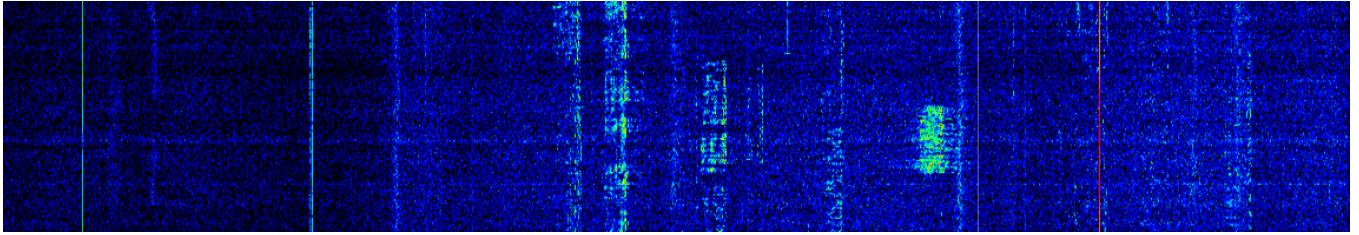

Waterfall graphic - timed spectrum scope in the format: amplitude - brightness, frequency - horizontal, time - vertical. The comfortable settings are set by default, but you can change them if necessary (more details in [Waterfall tab](#)³⁴).

3.2.5 Status bar

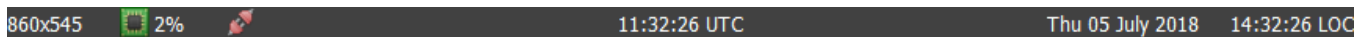

The status bar displays the following information (from left to right):

- ExpertSDR2 window resolution.
- CPU load in percent.
- Connection status to ColibriNANO (**red** - no connection; **blue** - connection).
- Coordinated Universal Time (UTC).
- Current date and Local Time.

3.3 Options

For fine tuning of the ExpertSDR2 software press the **Options** button in the top right corner of the software window.

Note:

- If you changed anything in the menu and you don't like it, but you forgot the default value, you can reset all setting to default values by simply clicking the **Global Default** button.
 - You can check the changes without leaving the **Options** window, just click the **Apply** button.
 - If you are satisfied with the changes and don't want to change anything else, click the **OK** button to close the **Options** window.
-

Warning!

- ① **We recommend you study this section of the manual very carefully because many settings are hidden in the sub-menus.**
-

3.3.1 Device menu

In the **Device** menu, you can find software functions of the signal processing and hardware settings.

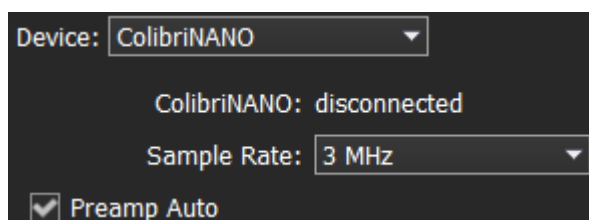

Device - device type menu. Shows that the ExpertSDR2 works in the ColibriNANO mode.

ColibriNANO: - shows the connection status between the receiver and PC. Even if the receiver is plugged in, but required USB drivers are not installed, the status would be disconnected.

Sample Rate - IF sample rate, equals the panorama bandwidth. You can select one of four panorama bandwidth values.

Preamp Auto - if enabled, this feature automatically adjusts preamp/attenuator level based on the signal level on the ADC input. The purpose of this feature is to maximize the ADC usage, but do not overload the ADC (we recommend keeping this feature ON).

3.3.1.1 VAC

If the ExpertSDR2 and digital modes software run on the same computer, they can be connected via a virtual audio cable without wires and sound cards.

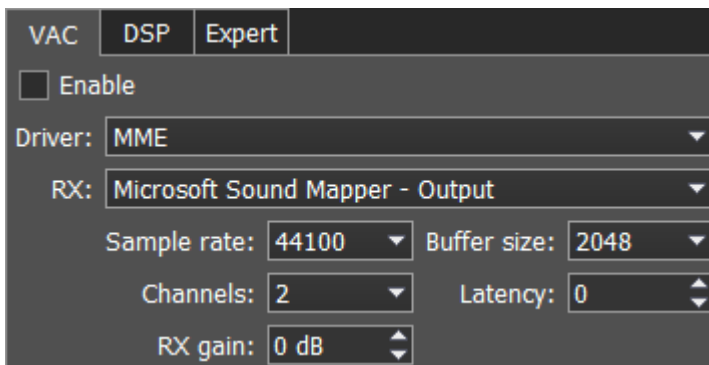

Enable - set the Enable checkbox to enable virtual audio cable.

Driver - select the audio cable's or sound card driver type.

RX - select the output for the audio signal received by the ExpertSDR2, which can be transferred to the third-party software via VAC.

- **Sample rate** - sampling frequency.
- **Buffer size** - size of the buffer.
- **Channels** - select the amount of the sound card's or virtual audio cable used channels.
- **Latency** - signal delay time.
- **RX gain** - additional signal amplifying in the virtual audio cable's RX path in dB.

Note:

- *Before enabling the VAC, make sure all settings for audio devices are correct.*
-

3.3.1.2 DSP

On the **DSP** tab you can see the AGC's and Digital Signals Processing settings.

There are two types of settings in the drop-down menu:

AGC - receiver's AGC settings.

DSP - digital processing filter's settings.

Receiver's AGC settings

There you can find fine AGC settings. AGC settings are divided by the processing speed on **Long, Slow, Med, Fast** and **User**.

Each settings type has its own tab and differs from others in terms of Attack, Decay and Hang time.

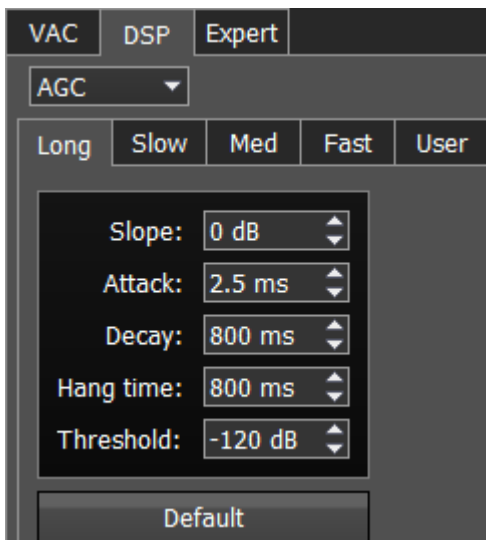

AGC parameters:

Slope - set the slope of the transfer characteristic.

Attack - when a signal gets stronger, this value determines how quickly the AGC will decrease gain.

Decay - when a signal gets weaker, this value determines how quickly the AGC will increase gain.

Hang time - signal recovery time.

Threshold - AGC trigger threshold.

Default - reset AGC setting to the default level. Press the Default button if you set wrong AGC values and don't like the result. Each AGC tab has a Default button.

Digital processing filter's settings.

There you can find fine the settings of the receiver's digital processing filters. DSP functions clear the signal from abnormal noises and crosstalk. These are the standard functions:

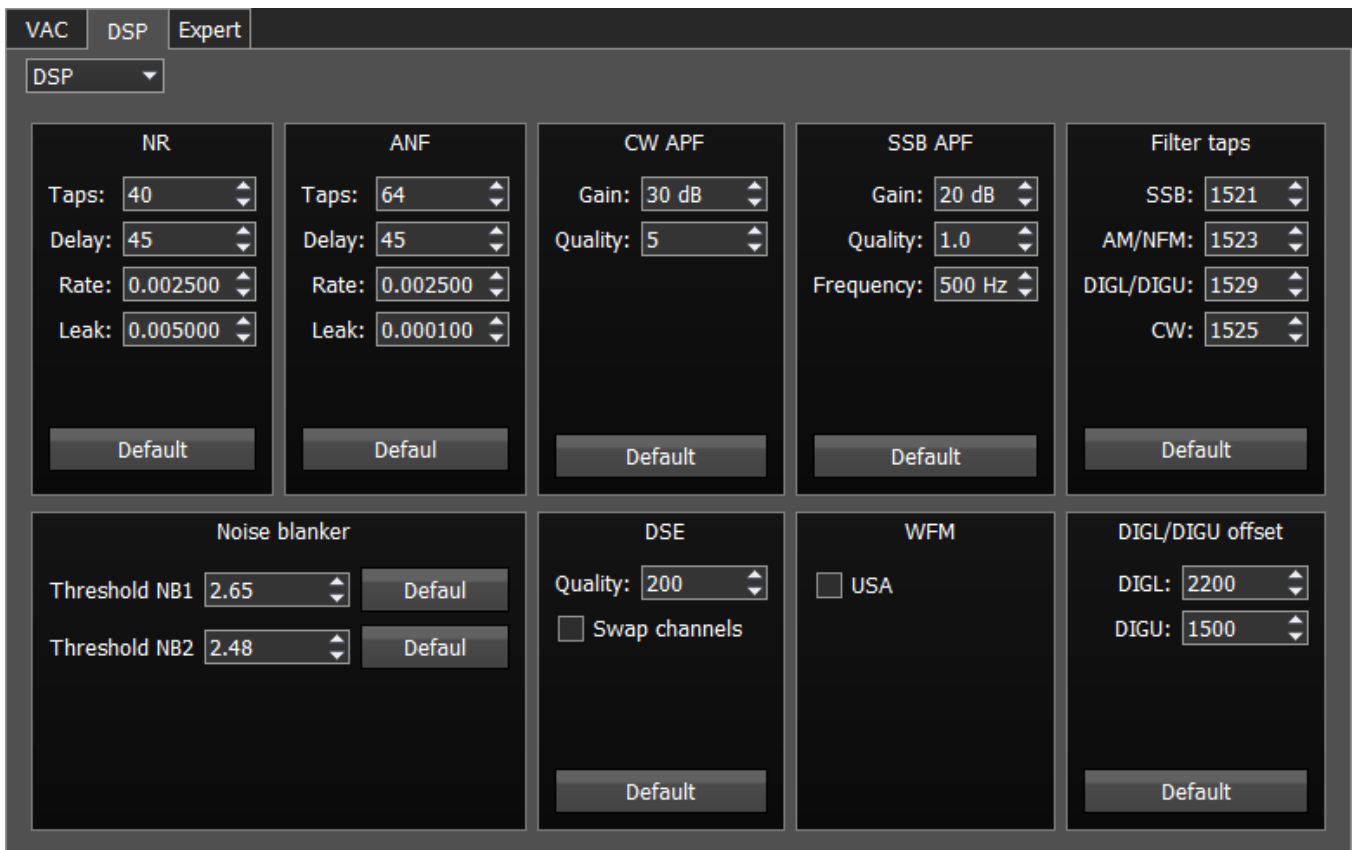

NR - Noise Reduction, removes the white noise. This is a special adaptive filter, which removes any abnormal noises from the air in the RX filter band.

ANF - Auto Notch filter, removes the carrier signals. This is a special adaptive filter, which removes any periodical signals from the air in the RX filter band.

- **Taps** - filter taps, determines the quality of the filter functionality.
- **Delay** - trigger delay time.
- **Rate** - set the adaptation rate of the filter.
- **Leak** - set the signal's level.

APF - Analog peak filter for CW and SSB mode. Provides a more comfortable listening of the CW signals by amplifying the CW signal in the center of the receive filter (triangle filter's AFC (amplitude-frequency characteristic) in the filter bandpass).

- **Gain** - Analog peak-filter amplifying factor.
- **Quality** - Analog peak-filter quality (slope sharpness).
- **Frequency** - central frequency of the voice signal.

Filter taps - receiver's filter taps for SSB, AM/NFM, DIGL/DIGU, CW modes, by default 1537.

The higher the receiver's filter taps value, the more rectangular the filter's shape, but it also increases the signal pass delay. That is why the user should find the best settings for himself,

between acceptable filter slopes steepness and signal delay. Optimal filter taps are set by default.

Noise blanker - removes impulse interference. Noise blanker parameters:

- **Threshold NB 1, 2** - filter trigger threshold. Set the required filter 1, 2 trigger thresholds, depends on the interference level.

Note:

- *NB has a threshold, set it to cut pulse noise if it surpasses the threshold. As a rule, pulse noise is a high-amplitude and short in time signal, with an amplitude much higher than useful signal. If it will be cut from the mix of signals the useful signal won't be corrupted. For correct operation, the threshold level should be adjusted higher than useful signals. In this case, NB will work perfectly. If the threshold will have the same level as useful signals or lower, the NB will try to cut useful signals and you'll hear and see distorted signals in phones and spectrum scope. If noises have white spectrum (not pulse) with low level (lower than useful signals), the NB cannot be used in this case, use NR.*

DSE - Digital Surround Effect for CW signals. Provides a space orientation in stereo phones, stations from lower frequencies are louder in the left channel, stations from higher frequencies are louder in the right channel. The signal in the filter's center is equally heard in both channels of stereo phones.

- **Quality** - DSE filter quality. The higher the quality value the stronger the function's effect.
- **Swap channels** - swap right and left receiver's channels. Set the Swap channels checkbox for correct DSE functionality, if required. Correct functionality - slowly increasing the receiver tuning frequency, while receiving the CW signal, sounds as if CW signal moves from the right to the left channel.

Note:

- *DSE effect cannot be heard in mono phones.*

WFM - Wide FM standard:

- **USA** - set this checkbox to listen to WFM stations in the USA or South Korea.

DIG offset - frequency offset, use when you operate in digital modes. Whether to use frequency offset or not depends on the digital mode software. Look for tips in the instruction for your digital mode software.

Default - press to return settings to the default state. Each settings category has the Default button. Press the Default button if you set wrong values and don't like the result.

3.3.1.3 Expert

On the **Expert** tab you can see the fine hardware settings of the receiver.

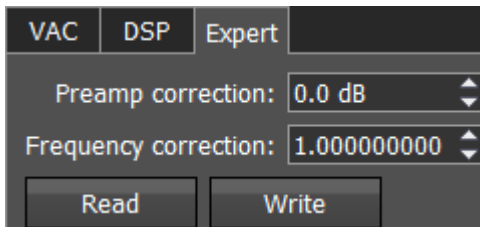

Note:

- All settings in this tab are stored in the receiver's non-volatile EEPROM memory.
- After setting the required values, set/unset checkboxes, press the **Write** button to save the settings.
- To read the current settings state from the memory, press the **Read** button. Auto-read happens with every software launch.

Preamp correction - correction menu created for operation with external preamps or attenuators, for compensation. If you plan to use the receiver without external devices, you don't need this menu.

Frequency coefficient - correction menu of the receiver's frequency tuning. Set the coefficient that the receiver's tuning frequency would be equal to the real frequency of the received signal.

Note:

- Correction of the displayed frequency could be made according to the time signals on the 4.996MHz, 9.996MHz or 14.996MHz (preferably) frequencies, where you can find easily tracked pulse signals. If they do not match with the tuned frequency, adjust the **Frequency coefficient** till the frequency match.
- The higher the frequency of the used time signal, the higher calibration accuracy.
- Calibration should be performed with the maximum panorama zoom and maximum FFT size of the panorama (more detail about FFT size in [Spectrum](#) ³²).
- After you set the frequency correction coefficient, press the **Write** button.
- The devices are calibrated at the manufacturing by default, additional calibration is not required.

Read - Read the hardware settings from the receiver's memory.

Write - Store the hardware settings in the receiver's memory.

3.3.2 Sound card menu

In the **Sound card** menu you can see the settings of the audio devices, which can be used with the receiver.

3.3.2.1 Sound card

In the **Sound card** category, you can see the settings of the sound card.

Note:

- Signal output delay via the sound card can reach 250-500 ms. It can be adjusted with buffer size (smaller values equal lower delay) or selecting different Audio driver (MME - the biggest latency / WDMKS - moderate latency / ASIO - minimal latency).

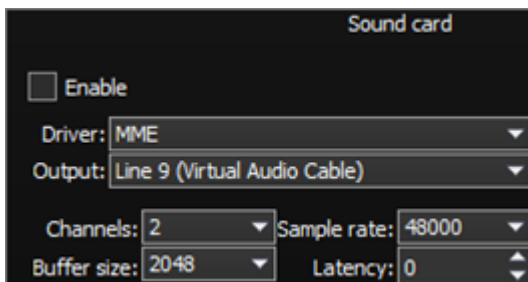

- **Enable** - Checkbox to enable PC's sound card.
Set the **Enable** checkbox to enable sound output via the sound card.
- **Driver** - Select the sound card's driver type.
- **Output** - Select the sound card's physical output.
- **Channels** - Select the amount of active sound card's channels.
- **Sample rate** - Sampling frequency.
- **Buffer size** - Buffer size.
- **Latency** - signal delay time.

Note:

- Before you'll enable the **Sound card** by the **Enable** checkbox, make sure that all sound devices settings are set correctly.

3.3.2.2 Line output

In the **Line output** category, you can see the settings of the sound card or virtual audio cables, which could be used for sound output.

Note:

- **Line output** - volume has a constant max value and cannot be changed by the operator.
 - As a rule, sound output via the **Line output** is used for recording communications in contests and other purposes.
-

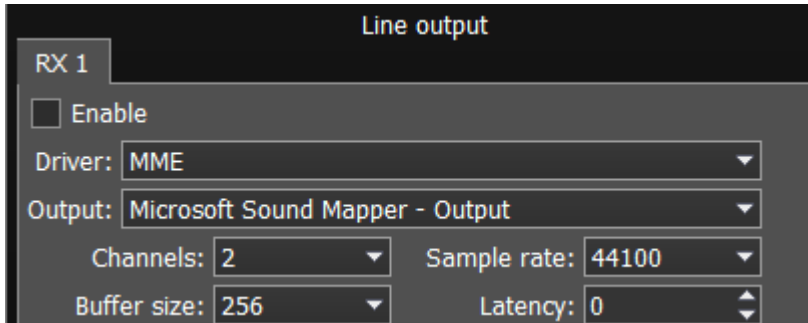

- **Enable** - Checkbox to enable **Line output**.
Set the **Enable** checkbox to enable **Line output**.
 - **Driver** - Choose the sound device' driver type.
 - **Output** - Choose the sound device' physical output.
 - **Channels** - Choose the amount of active sound device' channels.
 - **Sample rate** - Sampling frequency.
 - **Buffer size** - Buffer size.
 - **Latency** - signal delay time.
-

Note:

- Before you'll enable the **Line output** by the **Enable** checkbox, make sure that all sound devices settings are set correctly
-

3.3.3 Display menu

In the **Display** menu you can see the settings of the receiver's software display. Display settings are placed according to their functionality:

- **"Main window"** tab
- **"Spectrum"** tab
- **"Waterfall"** tab
- **"Grid"** tab
- **"Filter"** tab
- **"Background"** tab
- **"Indicators"** tab

3.3.3.1 Main window

On the **Main window** tab, you can see the settings of the main window display.

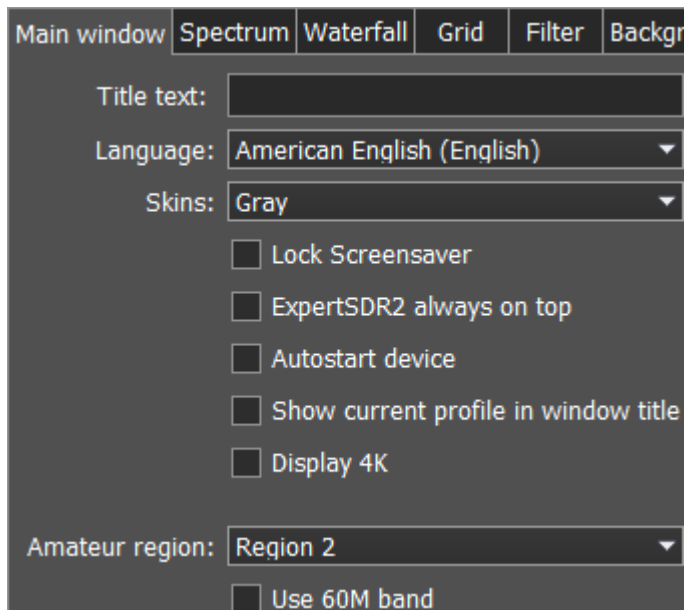

- **Title text** - Input box to enter the title.
Enter your call-sign or other information in the **Title text** box, it will always be displayed in the software title.
- **Language** - Interface language menu.
Select the required language from the list.
- **Skins** - Software color theme menu.
Select the required software color theme from the list.
- **Lock Screensaver** - Lock screen-saver checkbox.
Set the **Lock Screensaver** checkbox to block the display turn off by the Windows OS.
Recommended checkbox setting - on.
- **ExpertSDR2 stays on top** - On top checkbox.
Set the **ExpertSDR2 stays on top** checkbox to see ExpertSDR2 window constantly on top of other windows.
Recommended checkbox setting - off.
- **Autostart device** - Receiver's autostart checkbox.
Set the **Autostart device** checkbox to automatically start the receiver after the launch of the software.
Recommended checkbox setting - on.
- **Show current profile in window title** - Display the current profile in the software window title.
Set the **Show current profile in window title** checkbox to display the current profile (if the profile is on) in the software window title.
- **Display 4K** - display mode for 4K monitors.

- **Amateur region** - Amateur region menu.

Select the region you are currently in, in the Amateur region menu.

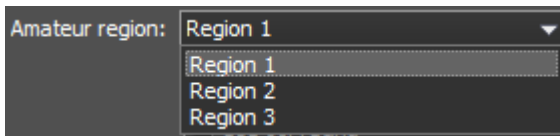

It affects the position of the amateur bands in the software.

- **Use 60M band** - set the **Use 60M band** checkbox to enable 60M band.

Note:

- *After you select the amateur region and/or set/unset the checkbox Use 60M band you'll see the notification window, that the settings will be applied after the restart of the software. Restart the software.*
-

3.3.3.2 Spectrum

On the **Spectrum** tab you can see the spectrum settings.

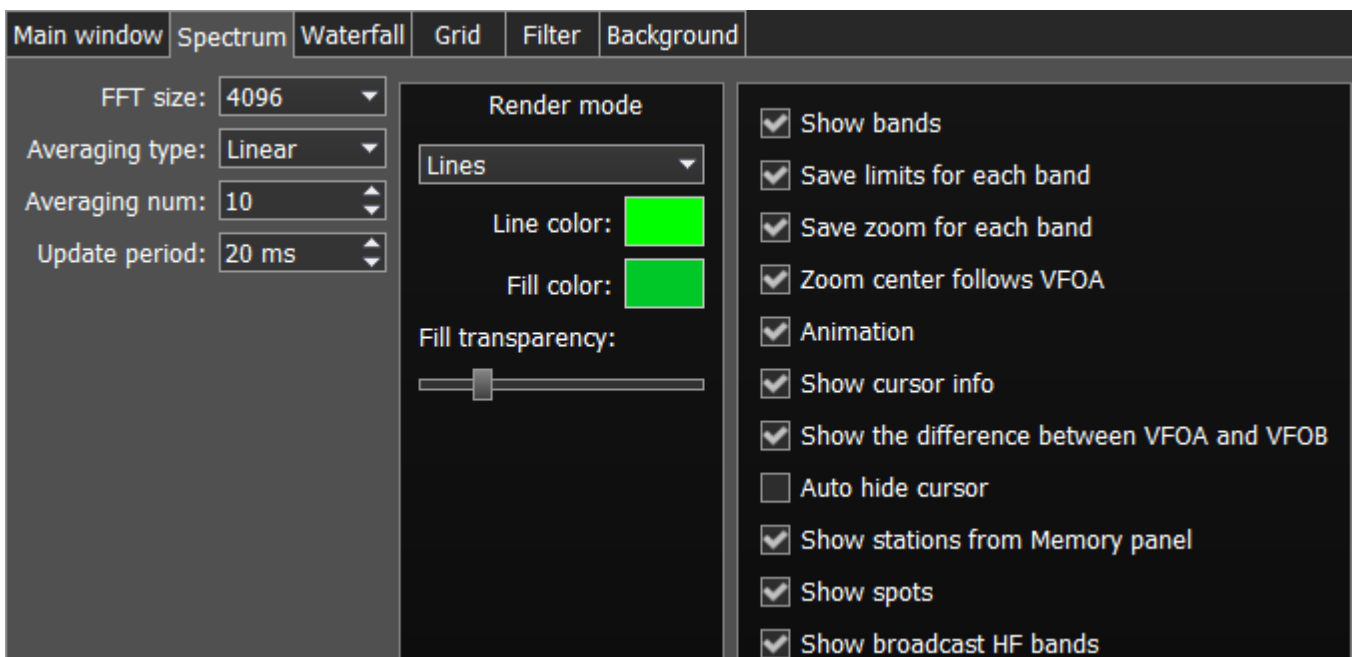

- **FFT size** - Fast Fourier Transform (FFT) size of the spectrum scope.
Select the required FFT size. The higher FFT size, the higher spectrum scope resolution by frequency, along with the higher processor load.
- **Averaging type** - Spectrum scope averaging type menu.
Select the averaging type from the list: Linear, root-mean-square (Rms), Exponential, which suits you best.
- **Averaging num** - A number of samples for averaging.
Set the required amount of samples for averaging. The bigger a number of samples, the slower the spectrum will change on the graph.

- **Update period** - Spectrum scope update period.
Set the required specter's graph update period. The bigger the number, the more FPS on the spectrum scope, along with the higher processor load.

Render mode - Spectrum render mode: lines, gradient.

Set the required specter render mode.

- **Line color** - Spectrum scope line color.
Select the required line color from the palette.
- **Fill color** - Fill color of the spectrum scope lower area.
Select the required fill color from the palette.
- **Fill transparency** - Transparency slider for the spectrum scope lower area filling.
Set the required filling transparency level.

- **Show bands** - Show amateur bands borders.
Set the **Show bands** checkbox to show amateur bands borders at the top of the spectrum scope (blue line).
- **Save limits for each band** - Save spectrum scope amplitude limits for each band.
Set the **Save limits for each band** checkbox to enable the software to save set spectrum scope limits for each band.
- **Save zoom for each band** - Save spectrum scope zoom settings for each band.
Set the **Save zoom for each band** checkbox to enable the software to save spectrum scope zoom settings for each band.
- **Zoom center follows VFOA** - Zoom center marker locked on the VFOA position on the spectrum scope.
Set the **Zoom center follows VFOA** checkbox to enable the zoom center marker lock on the VFOA position.
- **Animation** - Spectrum scope animation while transitioning between bands.
Set the **Animation** checkbox to enable animation.
- **Show cursor info** - Show frequency and dB level of the cursor position.
Set the **Show cursor info** checkbox to enable info display near the cursor on the spectrum scope.
- **Show the difference between VFOA and VFOB** - Show the difference between VFOA and VFOB.
Set the **Show the difference between VFOA and VFOB** checkbox to display the difference between VFOA and VFOB near the cursor.
- **Auto hide cursor** - Automatically hide the cursor from the spectrum scope.
Set the **Auto hide cursor** checkbox to let the cursor disappear after idle 2 seconds.

- **Show stations from Memory panel** - Show the stations previously stored in the frequency memory.
Set the **Show stations from Memory panel** checkbox to show on the spectrum scope previously stored stations as markers (blue dots in the top area of the spectrum scope). When rollover the station's marker you'll see the commentary.
- **Show spots** - Show spots from the CW Skimmer on the spectrum scope.
Set the **Show spots** checkbox to show spots from the CW Skimmer on the spectrum scope as a markers with call-signs.
- **Show broadcast HF bands** - enable for display of broadcast HF bands on panorama and Band Scope.

3.3.3.3 Waterfall

On the **Waterfall** tab you can see the waterfall settings.

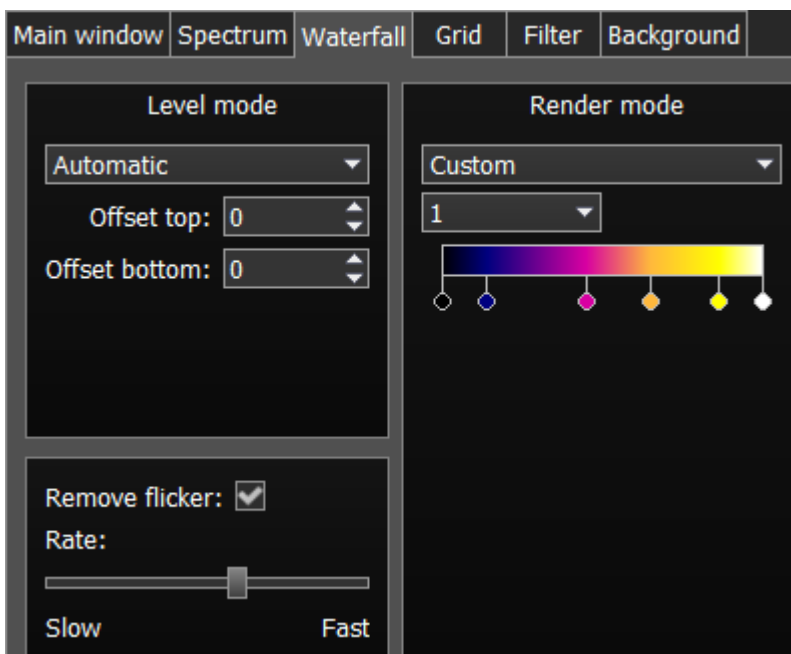

- **Level mode** - Waterfall bright menu.
Select the bright mode from the list: Automatic, Synchronous.
Automatic mode depends on air signals and set offset in the settings below.
Synchronous mode depends on the set limits of the spectrum amplitude.
- **Offset top** - Offset input box by the top dB level relatively to signals level.
Set the offset in the **Offset top** box to determine the maximum brightness relatively to the max signals' levels.
- **Offset bottom** - Offset input box by the bottom dB level relatively to signals level.
Set the offset in the **Offset bottom** box to determine the minimum brightness relatively to the min signals' levels.
- **Render mode** - waterfall render mode menu: Rainbow, Monochrome, Custom. Select the required color render of the waterfall, depending on your choice or tasks. In the Custom mode,

you have three colors presets: 1,2,3 and User adjustable mode.

In the User preset there are 6 color markers at maximum. Double click of the left mouse button on the color marker opens the color menu, double click of the right mouse button on the color marker delete it. Double click of the left mouse button on the empty space adds the color marker.

- **Remove flicker** - Checkbox to remove the waterfall flickers.

Set the **Remove flicker** checkbox to get rid of the texture flickers in the waterfall, also it slightly clears the waterfall from air noises.

- **Rate** - Waterfall movement speed slider.

Set the **Rate** slider according to the required waterfall movement speed.

3.3.3.4 Grid

On the **Grid** tab you can see the spectrum scope grid display settings.

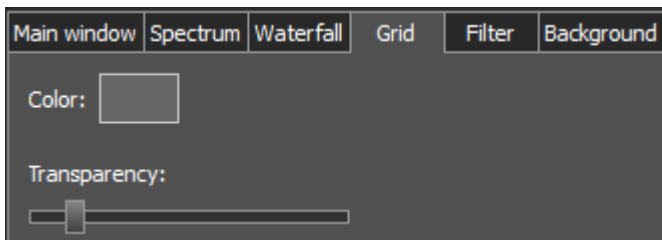

- **Color** - Color of the spectrum scope grid.
Select the required grid color from the palette.
- **Transparency** - Grid transparency slider.
Set the required grid transparency by moving the slider.

3.3.3.5 Filter

On the **Filter** tab you can set the required color of filters and the necessity to display the additional text information.

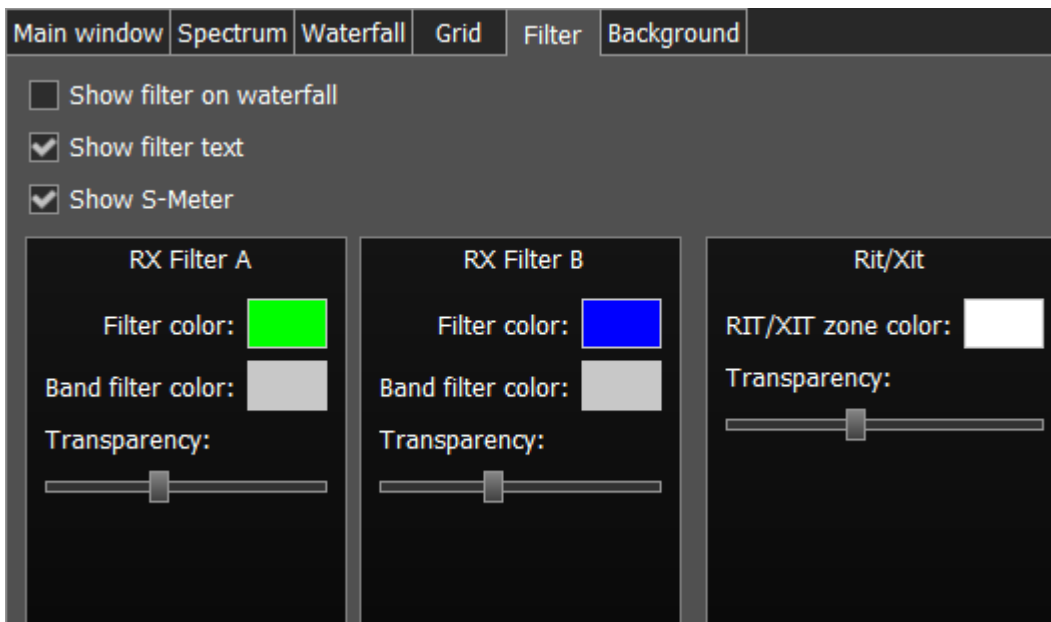

- **Show filter on waterfall** - Show receiver(s) filter on the waterfall.
Set the **Show filter on waterfall** checkbox to show receiver(s) filter on the waterfall.
- **Show filter text** - Show text info near the receiver's filter on the spectrum.
Set the **Show filter text** checkbox to display filter's tuned frequency, signal level in S-units etc. in the used filter bandwidth.
- **Show S-Meter** - Enable animated S-Meter near the receivers' filter on the spectrum.
Set the **Show S-Meter checkbox** to display S-Meter near the receiver's filter.

In the **RX Filter A**, **RX Filter B** categories displayed filters' color and transparency settings.

- **Filter color** - Filter's frequency color menu.
Choose the required filter's tuned frequency color from the palette.
- **Band filter color** - Filter's bandwidth color menu.
Choose the required filter's bandwidth color from the palette.
- **Transparency** - Filter's transparency slider.
Set the required filter's transparency.

In the **Rit/Xit** category displayed RIX active zone settings.

- **Rit/Xit zone color** - RIX active zone color menu.
Choose the required RIX active zone color from the palette.
- **Transparency** - RIX zone transparency slider.
Set the required RIX zone transparency.

3.3.3.6 Background

On the **Background** tab you can see the spectrum scope background settings.

Background type - Spectrum scope background type menu: **Solid**, **Gradient**, **Image**.
Select in the **Background type** menu spectrum scope background render type.

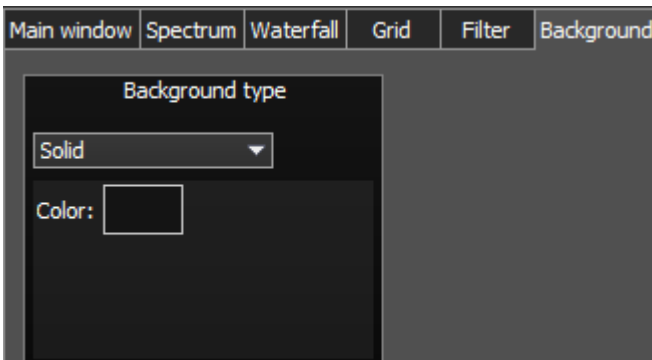

In the **Solid** mode available settings are:

- **Color** - Background color menu.
Choose the required background color from the palette.

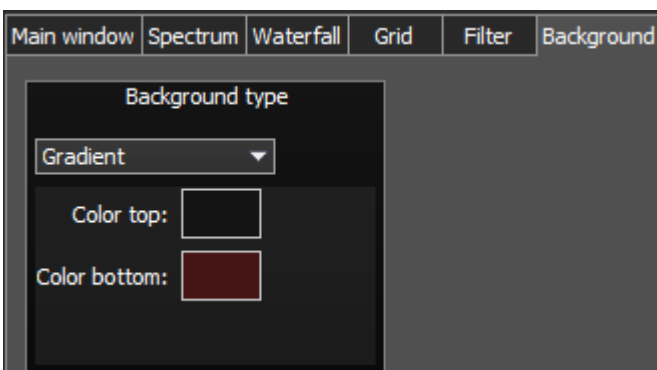

In the **Gradient** menu available settings are:

- **Color top** - Top gradient color of the background.
Choose the required top gradient color from the palette.
- **Color bottom** - Bottom gradient color of the background.
Choose the required bottom gradient color from the palette.

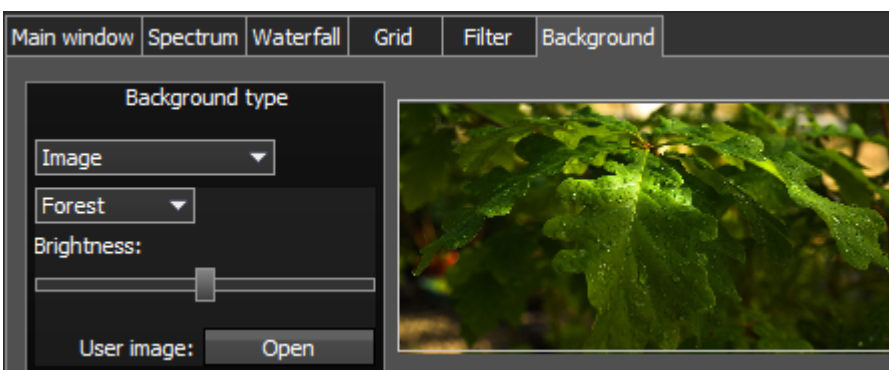

In the **Image** menu available settings are:

- **Image menu** - Image presets menu (Forrest, Bubbles, Space, Water, User).
Pick the required image from the menu or lock one of your own images.
- **Brightness** - Background image brightness slider.
Set the required background image brightness.
- **User image** - Choose the required image to be displayed on the background.
Press the **Open** button, in the opened window choose the image file to set as the background.

Note:

- If the image file wasn't chosen previously via the **Open** button, then if you choose the User image in the presets list it'll open the window to choose the image file.
 - Supported files types: png, jpg, jpeg, bmp.
-

3.3.4 CAT menu

In the **CAT** menu, you can see the CAT-system settings. CAT-system is the receiver's exchange interface with an external devices and software.

CAT-interface is used to control the receiver from a third-party software. This could be contest logs, digital modes decoder-software, SAT-tracker etc.

There are two ways to use the ColibriNANO with an external transceiver:

3.3.4.1 ECATv1

ExpertSDR2 software has the **ECATv1** protocol, use it to synchronize the ColibriNANO and your transceiver via [RigSync](#) software.

ECATv1 - exchange protocol compatible with TS-480 transceiver. This protocol allows to exchange data with an external devices and software via COM-port.

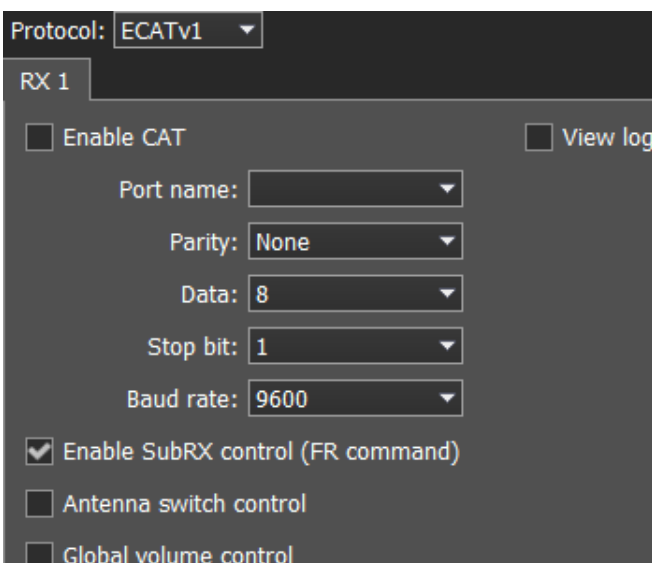

RX1 tab contains CAT-system settings via COM-ports.

- **Enable CAT** - Checkbox to enable control of the receiver via the CAT-system.

- **Port name** - COM-port number.
- **Parity** - Parity.
- **Data** - Amount of data in bits.
- **Stop bit** - Amount of stop bits.
- **Baud rate** - Port speed.

- **Enable SubRX control (FR command)** - Checkbox to enable control of the sub-receiver via the CAT-system.
Set the **Enable SubRX control (FR command)** checkbox to enable the control of the sub-receiver via the CAT-system.
- **Global volume control** - When this checkbox is enabled, you control the global volume with the Volume slider, on the top of the software window, from the CAT-system. Recommended when you use one RX or VFO A only, SubRX is disabled.
- **View log** - display CAT command log.

3.3.4.2 OmniRig

There is an experimental function to synchronize ColibriNANO with an external transceiver via the [OmniRig](#) software.

OmniRig - exchange protocol via the OmniRig software.

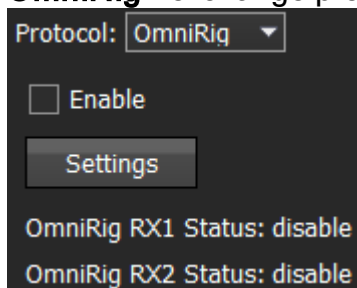

Note:

- Using the OmniRig software you can send a limited set of control commands.
 - Available control commands:
 - Set VFO frequency, if no VFOB in the CAT protocol;
 - Set VFO A frequency;
 - Set VFO B frequency;
 - Enable receiver's RIT offset;
 - Set RIT offset; - Reset RIT offset;
 - Enable transceiver's XIT offset;
 - Set mode type;
 - Enable SPLIT.
-

In the **OmniRig** menu you can find the settings of the OmniRig software.

Enable - set the **Enable** checkbox to control the receiver via the OmniRig software.

Settings - press the **Settings** button to open the OmniRig software settings.

Note:

- If the ExpertSDR2 software uses OmniRig protocol to exchange data with an external contest log software, which also uses OmniRig, then COM-port and other settings in the OmniRig software are not required. Select in the OmniRig settings any idle COM-port in the system, to avoid conflict.
-

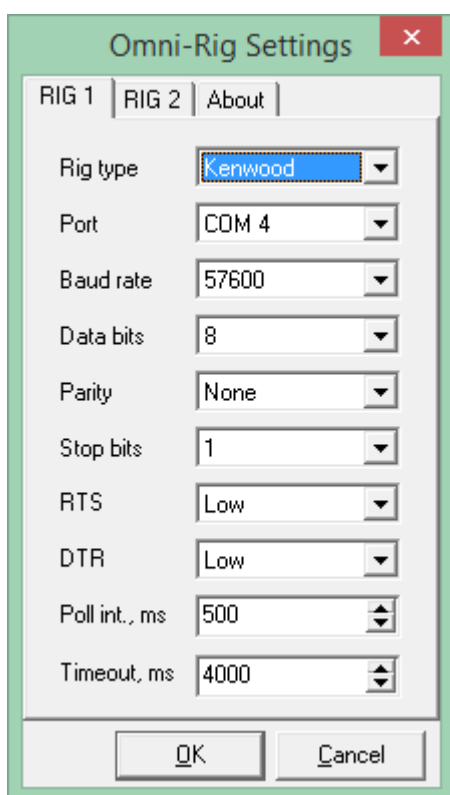

OmniRig RX1 Status - RX1 receiver and OmniRig connection status.

3.3.5 Panel menu

In the **Panel** menu you can see the settings of the E-Coder control panel.

In the drop-down Device menu, you can select the type of the connected control panel. In the meantime only one type is available - E-Coder.

Note:

- If there are several E-Coder panels connected to the PC with ColibriNANO, you'll see several tabs **E-Coder 1** , **E-Coder 2** etc. with identical settings for each panel, in the **Panel** menu.
-

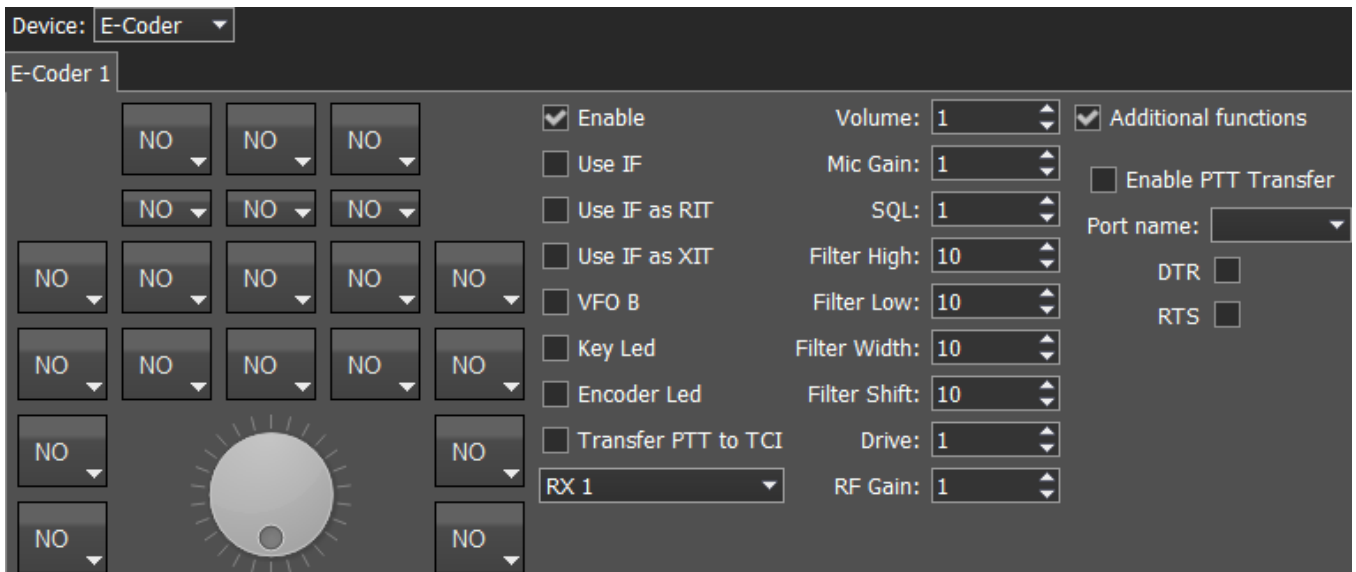

In the left part of the menu you can see the schematic picture of the E-Coder panel with buttons and knobs. Press any button, you'll see the list of the available functions.

Note:

- The list of the available functions is constantly growing. Keep track of the software updates.
 - You can make a request to add a new function on the control button.
-

The following functions may be assigned to the E-Coder panel buttons:

Unused - button is unused.

Main:

AGC Up/Down - AGC type switching.

Band Up/Down - band switching.

Filter Up/Down - receiver's filter switching.

Mode Up/Down - mode switching.

Preamp Up/Down - preamp or attenuator level switching.

Start/Stop - start/stop the ExpertSDR2.

Step Up/Down - change the tuning step.

Zoom In/Out - spectrum zoom modes switching.

VFO:

A>B - assign the frequency from heterodyne VFO A to heterodyne VFO B.

B>A - assign the frequency from heterodyne VFO B to heterodyne VFO A.

B<>A - frequency exchange between VFO A and VFO B.

Change VFO A/VFO B - switching between VFO A and VFO B.

IF as RIT - tune the RIT offset by moving the filter over the panorama.

LOCK - lock the frequency tuning.

RIT On/Off - enable/disable RIT offset.

RIT Reset - reset RIT offset to 0.

Sub RX On/Off - enable/disable SubRX.

Switch DDS/IF - tuning the frequency by moving the filter over the panorama, in other words changing the digital IF, or when filter stands still and spectrum moves, this is the central frequency tuning.

While you operate both VFO A and VFO B, usually you need to listen to either only one of them or both of them, but in different channels (left / right). To do that we added special functions to the E-Coder panel.

Audio:

Listen both VFO A/B - default settings, both VFOs have equal volume in both channels.

Listen VFO A only - listen to the VFO A in both channels.

Listen VFO B only - listen to the VFO B in both channels.

Listen VFO A in left channel, VFO B in right - listen to the VFO A in the left channel and VFO B in the right channel.

Listen VFO A in right channel, VFO B in left - listen to the VFO A in the right channel and VFO B in the left channel.

Mute - switch off the sound.

Volume Up/Down - volume adjustment.

DSP:

ANF - enable/disable auto notch filter.

APF - enable/disable analog pick filter.

BIN - enable/disable binaural mode.

NR - enable/disable noise reduction.

NB1 - enable/disable noise blanker 1.

NB2 - enable/disable noise blanker 2.

SQL - enable/disable squelch.

The following functions may be assigned on the E-Coder panel knobs:

Unused - encoder is unused.

Volume - volume adjustment.

SQL - squelch threshold adjustment.

Filter Low/High - tuning the frequency of the low/high filter's front.

Filter Width - adjusting the filter width.

Filter Shift - shifting the filter's central frequency.

IF - tuning the frequency by moving the filter over the panorama.

RF Gain - RF Gain control.

RIT Offset - adjusting the RIT Offset.

In the right part of the menu you can see the main panel settings:

Enable - enable E-Coder panel control.

Use IF - frequency tuning by moving the filter over the panorama.

Use IF as RIT - tuning by IF when the RIT offset is on.

VFO B - enable sub-receiver.

Key Led - enable backlit keypad.

Encoder Led - enable backlit encoder.

Volume - set the volume change step, per knob's clack.

SQL - set the squelch threshold change step, per knob's clack.

Filter High - set the filter's high limit change step, per knob's clack.

Filter Low - set the filter's low limit change step, per knob's clack.

Filter Width - set the filter's width change step, per knob's clack.

Filter Shift - set the filter's shift change step, per knob's clack.

RF Gain - set the RF gain step, per knob's clack.

There are three LEDs on the E-Coder panel, from left to right:

1) Lights **green** when the VFO B is active

2) Lights **red** when on TX

3) Lights **orange** when the RX2 is active

3.3.6 Features menu

In the **Features** menu you can set other programs to be launched along with the ExpertSDR2.

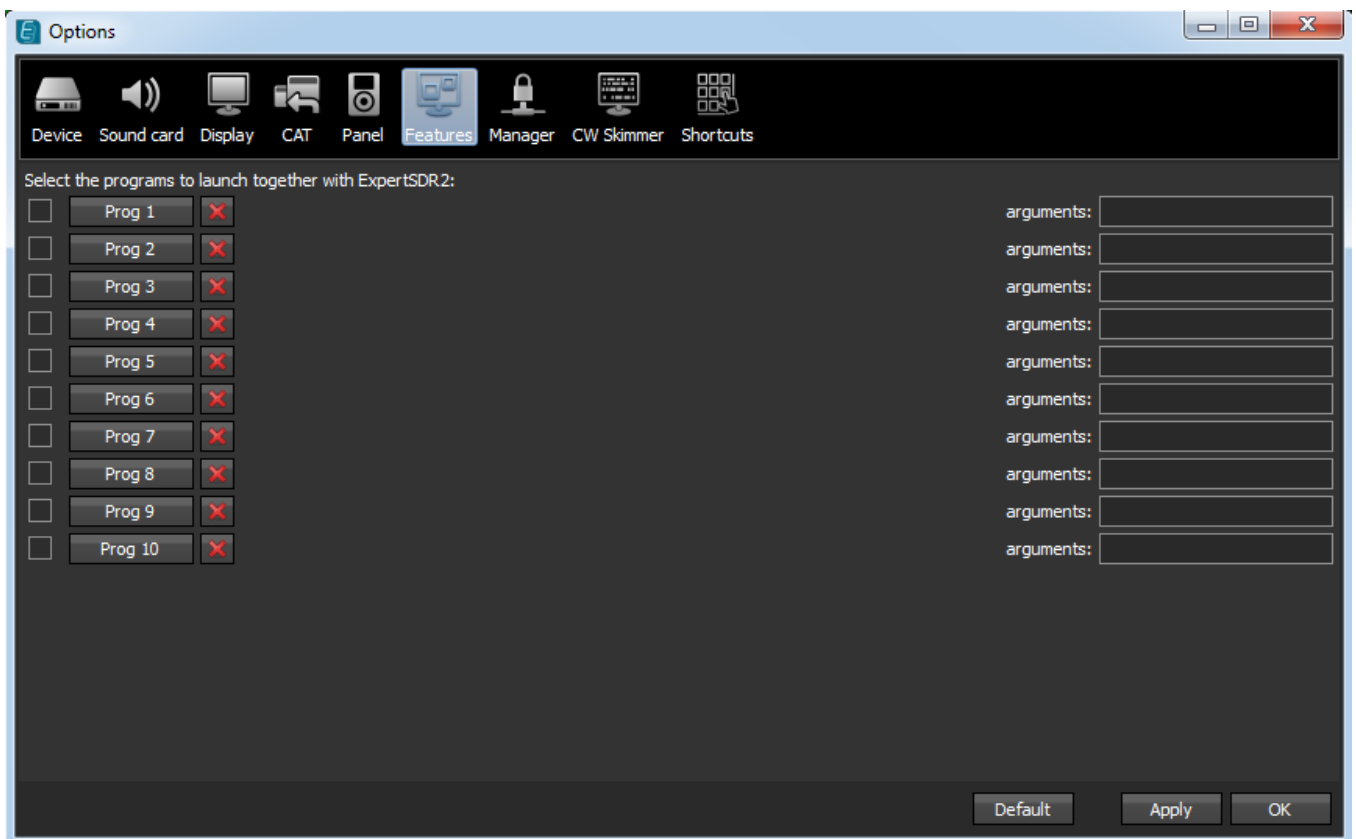

Enable checkbox - Enable autorun.

Set the **Enable** checkbox in front of the corresponding program in the list.

Program 1-10 - program's button.

Press the **Prog X** button to open the File explorer and select .exe file of the required program.

Delete button - Delete program.

Press the **Delete** button if you want to remove a program from the autorun list.

Arguments - Argument input box.

Enter some text in the **arguments** input box for the corresponding program.

Note:

- Arguments allow to the same program to be launched with different settings files etc.
 - Read an instruction for your software, to know which arguments are supported.
-

3.3.7 ExpertSync menu

In the **Manager** menu you can see the network synchronization settings between the receiver and other Expert Electronics devices.

This interface allows you to synchronize the tuning frequency and mode type between several Expert Electronics devices via the ExpertSync software ([you may download it from here](#)).

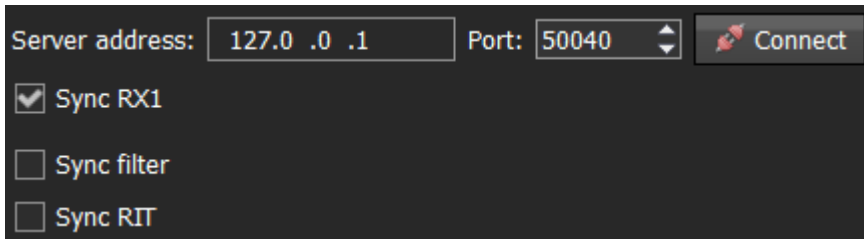

- **Server address** - ExpertSync server IP address.
Enter the ExpertSync server IP address. If the the ExpertSync server is launched on the receiver's PC, then the address will be 127.0.0.1.
- **Port** - Data exchange port.
Enter the exchange port number in the **Port** input box.
- **Connect** - Start the connection.
Press the **Connect** button to launch the connection between the receiver's software and ExpertSync. Blue indicator means there is a connection.
- **Sync RX1** - RX1 receiver sync button.
Set the **Sync RX1** checkbox to synchronize the RX1 receiver with the remote RX1 receiver.
- **Sync filter** - set the **Sync filter** checkbox to synchronize the filter bandwidth with the other device connected via the ExpertSync software.
- **Sync RIT** - set the **Sync RIT** checkbox to synchronize the receive frequency offset (RIT) with the other device connected via the ExpertSync software.

3.3.8 CW Skimmer menu

In the **CW Skimmer** menu, you can see the connection settings between the receiver software and CW Skimmer software or Internet spotter-server.

Settings in the **CW Skimmer** menu has two identical tabs RX1 with connection settings for each software receiver, let's look at one of them.

- **Connect** - Button to launch the connection with the CW Skimmer software or Internet server-spotter.
Press the **Connect** button, after adjusting all settings, to make a connection with the CW Skimmer software or Internet server-spotter.
- **Address** - IP address or DNS name of the CW Skimmer/server.
Enter this 127.0.0.1 address or localhost, if you want to connect to the CW Skimmer, which is installed on the receiver's PC.
- **Port** - Data exchange port.
Enter the exchange port number in the **Port** input box.
- **Callsign** - Callsign input box.
Enter your callsign if the server requires it.
- **Password** - Password.
Enter the password if the server requires it.

To transfer the IQ signal in the CW Skimmer you need to adjust the settings of the audio device in the **RX IQ output** category, it consists of:

- **Enable** checkbox - Enable the IQ signal transfer from the ExpertSDR2 to the CW Skimmer.
- **Driver** - Audio device driver type.
- **Output** - Audio device physical output.

- **Channels** - Amount of the used channels of the audio device.
 - **Sample rate** - Sampling frequency.
 - **Buffer size** - Buffer size.
 - **Latency** - Signal delay time.
-

Note:

- *If CW Skimmer is installed on the receiver's PC, then for the signal output you need to use Virtual Audio Cable.*
-

- **Sync frequency** - set the **Sync frequency** to synchronize the CW Skimmer frequency with ExpertSDR2 frequency.
- **Tune frequency from CW Skimmer** - CW Skimmer set the ExpertSDR2 frequency. Set the **Tune frequency from CW Skimmer** to tune the ExpertSDR2 frequency by the mouse click on the station in the CW Skimmer.

3.3.9 Shortcuts menu

In the **Shortcuts** menu, you can see the shortcut key combinations settings.

With the key combinations, you can control the receiver from your keyboard.

Note:

- *Shortcuts will be active only if the receiver's software window is in focus.*
-

<input type="checkbox"/> Enable		
Command	Shortcut	Shortcut RX1
Start Software	Press shortcut	
Options	Press shortcut	
RX2	Press shortcut	
Bandscope	Press shortcut	
Memory Panel	Press shortcut	
Increase Sample Rate	Press shortcut	
Decrease Sample Rate	Press shortcut	
Set RX Antenna	Press shortcut	
Set TX Antenna	Press shortcut	
Mute	Press shortcut	Press shortcut
RF Gain Up		Press shortcut
RF Gain Down		Press shortcut
Volume Up	Press shortcut	
Volume Down	Press shortcut	
VFOA Volume Up		Press shortcut

- **Enable** - Enable shortcuts.
Set the **Enable** checkbox to activate assigned shortcuts.
- **Command** - Functions column.
In the **Command** column displayed all receiver's functions available for shortcuts.
- **Shortcut** - Main shortcuts column.
In the **Shortcut** column you can set the main receiver's functions.
- **Shortcut RX1** - RX1 receiver shortcuts column.
In the **RX1 shortcut** column you can set RX1 receiver functions.
- **Press shortcut** - Shortcut button.
Press the **Shortcut** button, then press the key combination on the keyboard.
- To delete a shortcut, press the Del button on the keyboard.

3.3.10 IQ Recorder menu

In the **IQ Recorder** menu, you can select a folder where you will store IQ recordings.

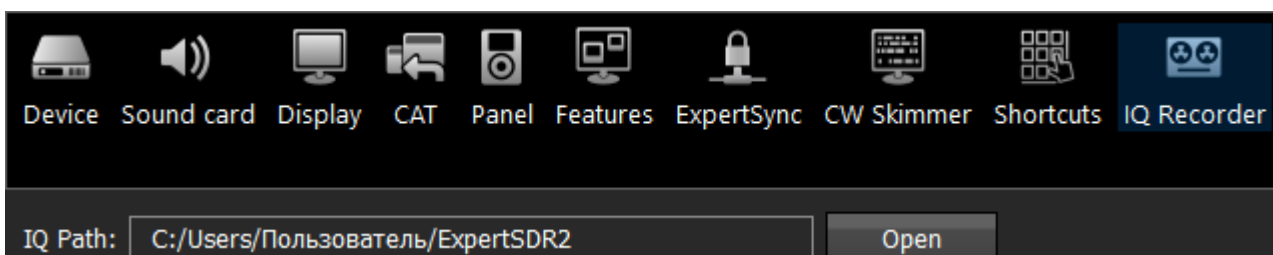

This is the first step on a way to a complete IQ Player.

3.3.11 TCI menu

In the **TCI** menu, you can select a port for TCI connection of ExpertSDR2 with a third-party software, with TCI support, and set the **Enable** checkbox.

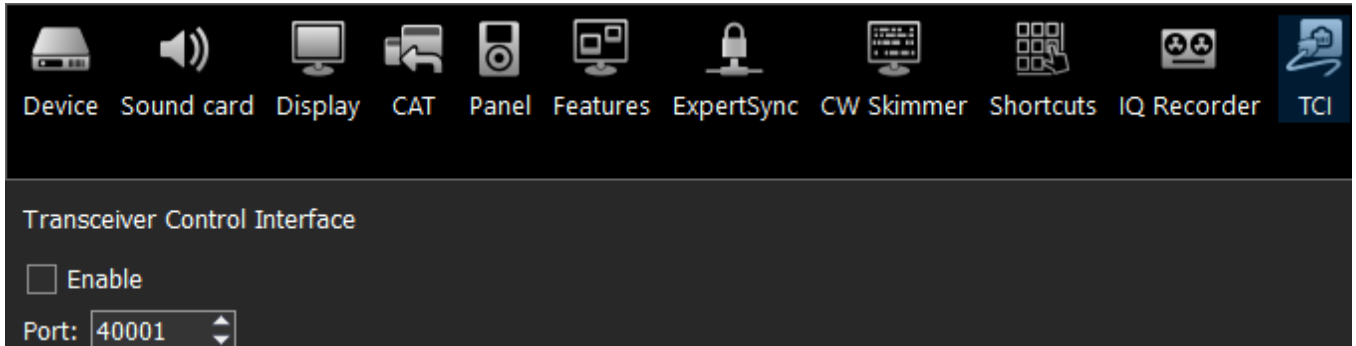

TCI - Transceiver Control Interface was developed by Expert Electronics company, for simple and still advanced connection between the ExpertSDR2 and third-party software. TCI has all required control commands similar to CAT system, but even more, it can transfer IQ-streams from the ExpertSDR2 to clients (third-party software such as signal Skimmers, etc) via local network and the Internet, CW macroses and Audio In/Out streams for digital modes (will be added soon). TCI is the universal multi-client interface (you can connect it to Loggers, Skimmers, PAs, Antenna switches etc. at the same time).

<https://github.com/maksim1210/TCI> - link to the list of files with the description of the interface in English and Russian and source code of the demo-client software with TCI support.

3.3.12 Spot settings menu

In the **Spot settings** menu, you can adjust spot settings you receive from CW Skimmer and telnet clusters.

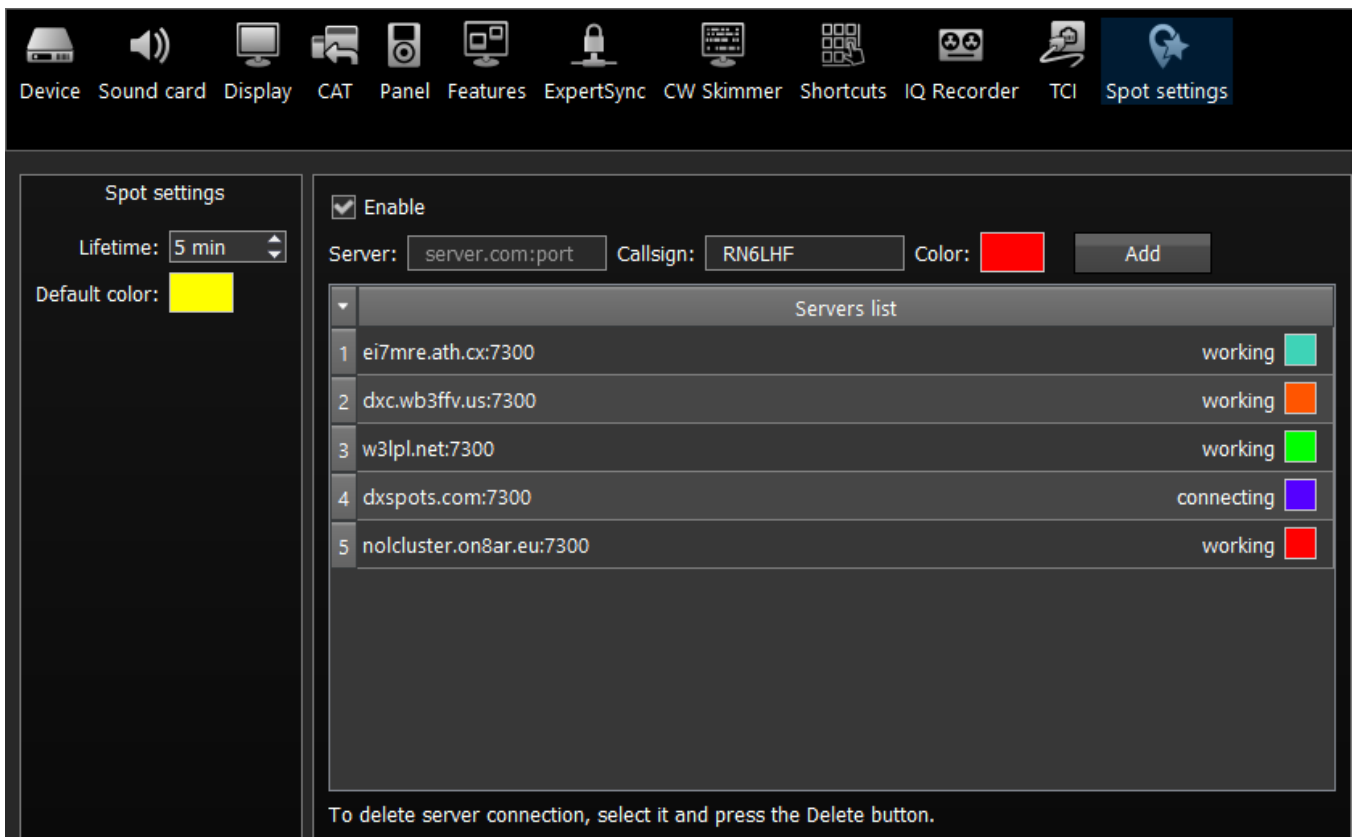

In the **Spot settings** section (left part of the menu) you can set up **Lifetime** and **Default color** for spots received from CW Skimmer.

In the right half of the menu you can add connections to telnet clusters to receive spots. To add a cluster, enter a server address (you may find examples on this website <http://www.dxcluster.info/telnet/index.php>), enter your callsign and select a certain color, press the **Add** button, it's done.

To delete a server connection, select it and press the Delete button on your keyboard.

Note:

- Don't forget to enable the **Show spots** checkbox in the [Spectrum tab](#) ³².
-

4 TECHNICAL CHARACTERISTICS

4.1 Receiver

Characteristic	Value
RX frequency range, MHz	0.01...55
RX frequency range in undersampling mode, MHz	0.01...500
ADC type	ADS4145
RF ADC clock frequency, MHz	122.88
RF ADC resolution, bit	14
Independent software receivers	1 (+1 SubRX)
Sample rate for each receiver, kHz	48; 96; 192; 384; 768 @ 24 bit 1536; 1920; 2560; 3072 @ 16 bit
Sensitivity on 20M band, preamp = 0, μ V	0.35
Noise floor, dBm	1.9 MHz (160M) - 131 7.1 MHz (40M) - 130 52.5 MHz (6M) - 127
Blocking Dynamic Range (BDR), dB	110
Dynamic Range over IMD3, dB	95
RMDR (Reciprocal Mixing Dynamic Range) with 1 kHz offset, dB	104
NPR (Noise Power Ratio) with Noise Bandwidth 5 MHz, dB	59
Local oscillator (TCXO), ppm	122.88 MHz +/- 0.5 ppm
Local attenuator with 0.5 dB step, dB	from -31.5 up to +6
Maximum antenna input voltage, without ADC overload, dBm (ATT=0 dB)	-14
Maximum antenna input voltage, without ADC overload, dBm (ATT= -31.5 dB)	17.5

ColibriNANO has an LPF for HF bands: 0-55 MHz (Eleptic - 9 order)

4.2 Other

Characteristic	Value
Dimensions L x W x H, cm (inches)	90 x 25 x 17 (3 1/2" x 1" x 5/8")
Weight, gram (ounce)	43 (1.52)
RF inputs	1 HF antenna connector: SMA connector with up to 15kV ESD protection
DC voltage range, V	4.5...5.5
Maximum power consumption, W	2.02
Maximum current consumption, A	0.41
Operating temperature, °C (°F)	-10...+60 (14...140)

5 RECEIVER OPERATIONS

This chapter describes all basic receiver functionality.

5.1 First set up

To operate the ColibriNANO receiver you'll need:

- PC or laptop:
 - 2x or 4x core CPU - Intel Core i3, i5, i7 or equal AMD processor; software can work on "weaker" CPU like Core2Duo or Dual-Core, but it may lead to an exceeding CPU load.
 - 8 GB RAM;
 - 40 GB free space on your HDD/SSD;
 - 15..27-inch monitor;
 - Video card which supports OpenGL 1.5 or higher.
 - Local network connector 100 Mbps or 1 Gbps
- Antenna, tuned on the HAM bands, should have impedance around 50 Ohm for those bands, where you plan to operate.

Supported operating system: Windows 7-10, OS Linux Ubuntu x64 and macOS 10.12 and newer.

Does not support Windows XP or earlier Windows versions!

Check your version of the Microsoft Visual C++ (click the right mouse button on the Windows Start button-> Programs and Features), before installation of the ExpertSDR2 software, if your installed version is above the one offered during installation, select "cancel".

When you plug the ColibriNANO in your PC, Windows will automatically download required USB driver (ensure PC is connected to the internet before connecting the ColibriNANO). Then receiver will be detected by Windows as new device, that's all, you may use the ColibriNANO.

If Windows will not automatically download required USB driver, download drivers from one of the links below and manually assign them to the undetected device in the **Device Manager** menu. Dismiss Windows warning regarding unsigned software and proceed with the installation.

[CDM v2.12.26 WHQL Certified x64](#) for 64-bit PC

[CDM v2.12.26 WHQL Certified x86](#) for 32-bit PC

Official driver installation guides for:

[Windows 7](#)

[Windows 8](#)

[Windows 10](#)

5.2 Remote operation

Remote operation with the ColibriNANO receiver

To control the ColibriNANO via Internet we created the **ExpertRemote** system, based on the client-server connection. This system allows you to place the receiver and server in the remote location with low air noise and Internet connection. This might be some remote village or place with no electrical interference and 3G/4G Internet (or any other connection type). Using the **ExpertRemote** system you can enjoy clear air from your phone, tablet, notebook or PC. Even simple antennas, placed in a "quiet" place, allows you to listen to the far stations with low level.

Another feature of this system is that the receiver's software can be synchronized with transceivers and be used as the panorama adapter with high resolution. Use the transceiver to transmit signals, receive on your remotely located receiver via the **ExpertRemote** system.

Distant stations, rare (DX) stations or expeditions from now on will be a reality for you with our **ExpertRemote** system!

More information about the **ExpertRemote** system you can find in the manual, published on our [website](#).

ExpertRemote system block-diagram

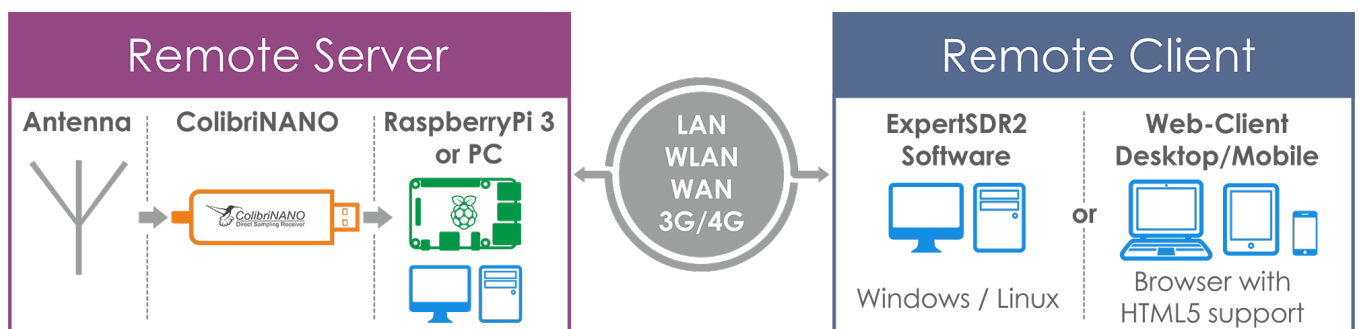

5.3 Frequency Tuning

There are several ways of the **frequency tuning**:

- **Fine tuning.**

More accurate tuning can be performed by rotating the mouse wheel with the accuracy specified in the **STEP** menu.

- **Quick tuning by the mouse click.**

On the spectrum, scope mouse cursor looks like the crosshair. Alongside this cursor displayed the exact frequency and dBm level in the certain point. The RX filter moves to this position by the click of the left mouse button.

Note:

- If the **Sub-receiver** or **SPLIT** mode is enabled, to use the **Quick tuning by the mouse click** with the **VFO A** or **VFO B** press the **mouse wheel** on the panorama. The mouse cursor color will change to match the controlled receiver - color of the mouse cursor also match the receiver's tuning line.
 - Use both the **Quick tuning by the mouse click** and **Fine tuning** modes. Click on the station and perform a fine tuning with the wheel if you slightly missed.
-

- **Dragging the RX filter over the spectrum scope.**
Press and hold the left mouse button on the filter, then drag it left/right to the required position.
 - **Moving the spectrum, the RX filter stands still.**
Press and hold the right mouse button anywhere on the spectrum, then move the spectrum, the filter will not change its position relatively to the spectrum. Tuning is carried out with the current **STEP** value.
 - **Moving the spectrum, the RX filter moves along.**
Press and hold the right mouse button anywhere on the filter and move it left/right.
-

Note:

- *Basically, this is not a way of tuning. It allows observing the air outside the panorama window, not changing the tuning frequency.*
-

- **Click on the digit of the frequency indicator.**
Left button - increase value; right button - decrease value; wheel - all digits on the right become zero.
- **Rotate mouse wheel on the digit of the frequency indicator.**
Rotate forward - increase value; rotate backward - decrease the value.
- **Synchronous tuning by the click on the bandscope.**
Hover the mouse cursor on the required place on the bandscope and click left mouse button - RX filter will move to the required location on both bandscope and panorama.

5.4 RIT

RIT offset means that signal receiving will be held on a frequency + Rit offset. Offset is displayed as a translucent band on the spectrum scope. Tuned frequency displayed as the red line. RX frequency displayed as the green line with the filter band (on the picture you can see USB mode).

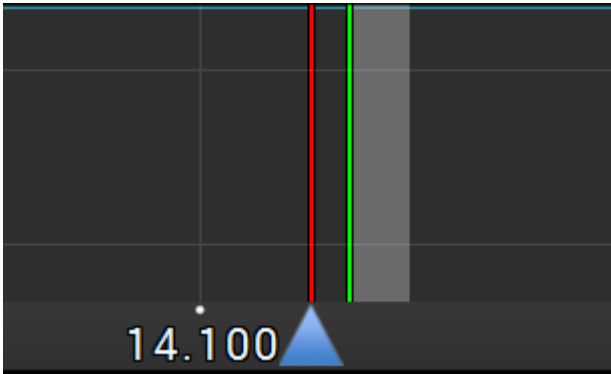

The following values will be displayed below the main receiver's frequency indicator:

RIT: - the frequency offset.

L: and **H:** - low and high filter's edges frequencies.

O: - mouse cursor frequency inside the filter.

To change the filter bandwidth: move the mouse cursor over the filter edge, it will be highlighted, then drag the edge with the left mouse button.

When the **RIT** is enabled, frequency tuning changes a bit:

Press and hold the left mouse button inside the RX filter to move it over the panorama.

Press and hold the left right button inside the RX filter to move the whole panorama with the filter.

Press and hold the middle mouse button inside the RX filter then move the mouse cursor out of the filter bandwidth, the **O:** indicator will show the frequency difference between the mouse cursor and the RX filter.

Note:

- If the **RIT** offset wasn't reset, when you disable the **RIT** its state will be saved. When you activate the **RIT** next time, the offset will equal the previous value.

5.5 Digital modes operation

The ColibriNANO receiver allows you to operate in digital modes with the help of the certain programs (which are not provided by the manufacturer).

Note:

- More information about the ColibriNANO operation in digital modes will be explained in the new version of the User Manual.
-